

MANHOLE COVER PRODUCTION
MCP SPA



Casa fondata nel 1882



Mario Cirino Pomicino



La garanzia del risultato



**chiusini, caditoie e griglie
in ghisa sferoidale**

**canalette in cemento
polimerico**

arredo urbano

juta e sacconi



2025

Mega centro altamente specializzato dove trovi qualità, competenza, assortimento, celerità, risparmio.

The first and sole highly specialized great retailing centre where you can find quality, competence, assortment, celerity and saving.

Consegne tempestive per ogni esigenza, anche per minimi quantitativi.

Quick deliveries also for small orders.

Presenti su tutto il territorio nazionale e internazionale con una rete di agenti che assiste quotidianamente la clientela fornendo qualsiasi informazione tecnico-commerciale.

We are present all over Italy and abroad with a capillary distribution network of agents, which follow our customers daily, providing them with any kind of technical-commercial information.

Consegriamo anche **1** solo pezzo
We deliver even **1** piece

In **48** ore con formula espressa
In **48** hours with express delivery

In tutta **Europa**
In all over **Europe**

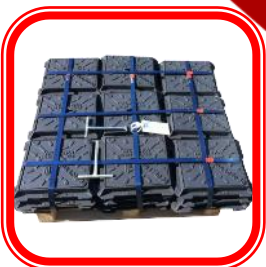
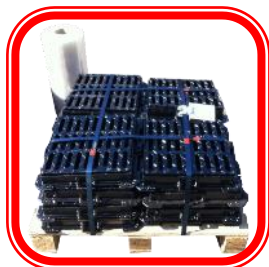

La filosofia operativa aziendale punta alla soddisfazione del cliente, principale obiettivo della catena produttiva, ogni particolare è ideato sulla base delle esigenze di mercato.

Il cliente può indicare la composizione dei PALLET con il numero di pezzi e dei modelli desiderati secondo le proprie esigenze dimensionali e logistiche senza alcun addebito aggiuntivo.

L'indiscussa qualità dei materiali, il vastissimo assortimento ed i prezzi estremamente competitivi, fanno della nostra azienda un punto di riferimento altamente specializzato per:

- ⇒ Rivendite di materiali edili;
- ⇒ Imprese edili, stradali, impiantistiche;
- ⇒ Comuni, Regioni, Province, Enti pubblici e privati;
- ⇒ Aziende municipalizzate, energetiche e di telecomunicazioni;
- ⇒ Studi tecnici e di progettazione;
- ⇒ Direzione lavori.

MCP SPA® aims to the full satisfaction of our customers, first goal of the production chain, therefore items are designed based on the market requirements.

Customers may request customized in number of pieces and models pallets according to their dimensional and logistic needs without extra charges.

The undisputed quality of the materials, a very wide range of products and really competitive prices make our Company an highly qualified reference point for:

- ⇒ Building materials retailers;
- ⇒ Building contractors ;
- ⇒ Municipalities, Public and private bodies;
- ⇒ Cables, Oil, Gas, Water companies;
- ⇒ Technical and designing offices.



ANCHE 1 SOLO PEZZO IN 48 ORE !!!



INDICE

INDEX

INDICE PER CLASSI DI CARRABILITA' (Chiusini, Caditoie, Griglie e Canalette) INDEX BY LOADING CLASSES (Manholes, Gully Tops, Grates and Channels)	pag. 2
LA STORIA HISTORY	pag. 6
L'AZIENDA COMPANY	pag. 7
CONFORMITA' ALLE NORME COMPLIANCE WITH STANDARDS	pag. 10
POSA IN OPERA INSTALLATION	pag. 16
ISTRUZIONI PER L'USO INSTRUCTIONS FOR USE	pag. 18



CHIUSINI
MANHOLE TOPS

pag. 21

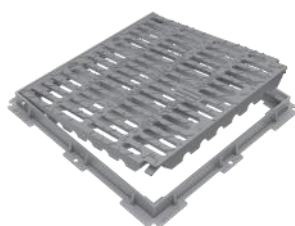

CADITOE
GULLY TOPS

pag. 55



GRIGLIE E CANALETTE
GRATE AND CHANNEL

pag. 71



TUBI CENTRIFUGATI
PIPES

pag. 78











ARREDO URBANO E DA GIARDINO
STREET AND GARDEN FURNISHING

pag. 79





JUTA
JUTE











pag. 105



















CLASSE CLASS	SERIE SERIES	FORMA SHAPE		CARATTERISTICHE CHARACTERISTICS										PAGINA PAGE
		TELAIO FRAME	COPERCHIO COVER											



B125 	LEONARDO ICON	<input type="checkbox"/>	<input type="checkbox"/>	✓												22	
	LEONARDO	<input type="checkbox"/>	<input type="checkbox"/>	✓										✓			27
	PAVE'	<input type="checkbox"/>	<input type="checkbox"/>	✓													32
	CARAVAGGIO	<input type="checkbox"/>	<input type="checkbox"/>														32
	MASACCIO	<input type="checkbox"/>	<input type="checkbox"/>	✓													33
	TIZIANO	<input type="checkbox"/>	<input type="checkbox"/>					✓	✓								50
		<input type="checkbox"/>	<input type="checkbox"/>					✓	✓		✓						
	DALI'	<input type="checkbox"/>	<input type="checkbox"/>												✓		54







C250  	LEONARDO ICON	<input type="checkbox"/>	<input type="checkbox"/>	✓												22	
	LEONARDO	<input type="checkbox"/>	<input type="checkbox"/>	✓										✓			27
	PAVE'	<input type="checkbox"/>	<input type="checkbox"/>	✓													32
	SIRONI	<input type="checkbox"/>	<input type="checkbox"/>	✓													33
	MASACCIO	<input type="checkbox"/>	<input type="checkbox"/>	✓													33
	GIAMBELLINO	<input type="checkbox"/>	<input type="checkbox"/>													✓	34
	TINTORETTO	<input type="checkbox"/>	<input type="checkbox"/>											✓			30

D400  	LEONARDO ICON	<input type="checkbox"/>	<input type="checkbox"/>	✓									✓	✓		23	
	LEONARDO	<input type="checkbox"/>	<input type="checkbox"/>	✓										✓			27
	LEONARDO TENUTA STAGNA	<input type="checkbox"/>	<input type="checkbox"/>		✓	✓									✓		24
	PAVE'	<input type="checkbox"/>	<input type="checkbox"/>	✓													32
	CEZANNE	<input type="checkbox"/>	<input type="checkbox"/>														70
	MASACCIO	<input type="checkbox"/>	<input type="checkbox"/>	✓													33
	GIAMBELLINO	<input type="checkbox"/>	<input type="checkbox"/>													✓	34
		<input type="checkbox"/>	<input type="checkbox"/>													✓	35
	TINTORETTO	<input type="checkbox"/>	<input type="checkbox"/>		✓			✓			✓	✓					29
		<input type="checkbox"/>	<input type="checkbox"/>	✓	✓										✓		31
		<input type="checkbox"/>	<input type="checkbox"/>											✓			30
	TELEFONIA	<input type="checkbox"/>	<input type="checkbox"/>					✓	✓		✓	✓					36
	COLOSSUS	<input type="checkbox"/>	<input type="checkbox"/>		✓			✓	✓					✓			40
	SPARTAN	<input type="checkbox"/>	<input type="checkbox"/>		✓			✓	✓					✓			41
RAFFAELLO ICON RAFFAELLO	<input type="checkbox"/>	<input type="checkbox"/>		✓			✓	✓					✓			42	
	<input type="checkbox"/>	<input type="checkbox"/>		✓			✓	✓					✓				
	<input type="checkbox"/>	<input type="checkbox"/>		✓			✓	✓					✓				

CLASSE CLASS	SERIE SERIES	FORMA SHAPE		CARATTERISTICHE CHARACTERISTICS										PAGINA PAGE
		TELAIO FRAME	COPERCHIO COVER											

D400  	GIOTTO			<input checked="" type="checkbox"/>	<input checked="" type="checkbox"/>	<input checked="" type="checkbox"/>	<input checked="" type="checkbox"/>	<input checked="" type="checkbox"/>	<input type="checkbox"/>	<input type="checkbox"/>	<input type="checkbox"/>	<input type="checkbox"/>	<input type="checkbox"/>	<input type="checkbox"/>	46	
	ICON			<input checked="" type="checkbox"/>	<input checked="" type="checkbox"/>	<input checked="" type="checkbox"/>	<input checked="" type="checkbox"/>	<input checked="" type="checkbox"/>	<input checked="" type="checkbox"/>	<input type="checkbox"/>	<input type="checkbox"/>	<input type="checkbox"/>	<input type="checkbox"/>	<input type="checkbox"/>	<input type="checkbox"/>	
	CSUNI			CHIUSINI PER SARACINESCHE SURFACE BOXES										50		
	MUNCH			<input type="checkbox"/>	<input type="checkbox"/>	<input type="checkbox"/>	<input type="checkbox"/>	<input type="checkbox"/>	<input type="checkbox"/>	<input type="checkbox"/>	<input type="checkbox"/>	<input type="checkbox"/>	<input type="checkbox"/>	<input checked="" type="checkbox"/>	<input type="checkbox"/>	51
	MODIGLIANI			<input checked="" type="checkbox"/>	<input checked="" type="checkbox"/>	<input checked="" type="checkbox"/>	<input checked="" type="checkbox"/>	<input checked="" type="checkbox"/>	<input checked="" type="checkbox"/>	<input checked="" type="checkbox"/>	<input checked="" type="checkbox"/>	<input type="checkbox"/>	<input type="checkbox"/>	<input checked="" type="checkbox"/>	<input checked="" type="checkbox"/>	52
				<input checked="" type="checkbox"/>	<input checked="" type="checkbox"/>	<input checked="" type="checkbox"/>	<input checked="" type="checkbox"/>	<input checked="" type="checkbox"/>	<input checked="" type="checkbox"/>	<input checked="" type="checkbox"/>	<input checked="" type="checkbox"/>	<input checked="" type="checkbox"/>	<input checked="" type="checkbox"/>	<input checked="" type="checkbox"/>	<input checked="" type="checkbox"/>	
	HIDRO			<input checked="" type="checkbox"/>	<input checked="" type="checkbox"/>	<input checked="" type="checkbox"/>	<input type="checkbox"/>	<input type="checkbox"/>	<input type="checkbox"/>	<input type="checkbox"/>	<input type="checkbox"/>	<input type="checkbox"/>	<input type="checkbox"/>	<input checked="" type="checkbox"/>	<input type="checkbox"/>	53
	DALI'			<input checked="" type="checkbox"/>	<input checked="" type="checkbox"/>	<input checked="" type="checkbox"/>	<input type="checkbox"/>	<input type="checkbox"/>	<input type="checkbox"/>	<input type="checkbox"/>	<input type="checkbox"/>	<input type="checkbox"/>	<input type="checkbox"/>	<input checked="" type="checkbox"/>	<input type="checkbox"/>	54

E600 	RAFFAELLO			<input checked="" type="checkbox"/>	<input checked="" type="checkbox"/>	<input checked="" type="checkbox"/>	<input checked="" type="checkbox"/>	<input checked="" type="checkbox"/>	<input checked="" type="checkbox"/>	<input type="checkbox"/>	<input type="checkbox"/>	<input type="checkbox"/>	<input type="checkbox"/>	<input type="checkbox"/>	45
---	-----------	---	---	-------------------------------------	-------------------------------------	-------------------------------------	-------------------------------------	-------------------------------------	-------------------------------------	--------------------------	--------------------------	--------------------------	--------------------------	--------------------------	----

F900 	LEONARDO ICON			<input checked="" type="checkbox"/>	<input type="checkbox"/>	<input type="checkbox"/>	<input type="checkbox"/>	<input type="checkbox"/>	<input type="checkbox"/>	<input type="checkbox"/>	<input type="checkbox"/>	<input type="checkbox"/>	<input checked="" type="checkbox"/>	<input type="checkbox"/>	24
	TELEFONIA			<input checked="" type="checkbox"/>	<input checked="" type="checkbox"/>	<input checked="" type="checkbox"/>	<input checked="" type="checkbox"/>	<input checked="" type="checkbox"/>	<input checked="" type="checkbox"/>	<input checked="" type="checkbox"/>	<input checked="" type="checkbox"/>	<input checked="" type="checkbox"/>	<input type="checkbox"/>	<input type="checkbox"/>	39
	RAFFAELLO			<input checked="" type="checkbox"/>	<input checked="" type="checkbox"/>	<input checked="" type="checkbox"/>	<input checked="" type="checkbox"/>	<input checked="" type="checkbox"/>	<input checked="" type="checkbox"/>	<input checked="" type="checkbox"/>	<input checked="" type="checkbox"/>	<input checked="" type="checkbox"/>	<input checked="" type="checkbox"/>	<input type="checkbox"/>	43



LEGENDA
LEGEND

 ERMETICO AIRTIGHT	 GUARNIZIONE CUSHIONING INSERT	 TENUTA STAGNA WATERTIGHT COVER	 CHIUSURA AUTOMATICA AUTO LOCKING	 KEY	 BULLONATO BOLTED	 RIEMPIMENTO RECESSED COVER
 CERNIERA HINGE	 90° BLOCK CERNIERA HINGE	 110° MAX CERNIERA HINGE	 ASSISTITO ASSISTED			

Le caratteristiche indicate possono essere presenti anche solo parzialmente nelle relative serie. Consultare le relative pagine per maggiori dettagli.
The characteristics indicated can be partially present in the relative series. Refer to related pages for details.

INDICE PER CLASSI DI CARRABILITA'

INDEX BY LOADING CLASSES

CANALETTE

CLASSE CLASS	SERIE SERIES	LONGHERONE BAR	FISSAGGIO FASTENED			PAGINA PAGE
			SEMPLICE PRESSIONE BY SIMPLE PRESSURE	A PONTE WITH CLAMP	CON BULLONI WITH BOLTS	
A15 	HYDRO		✓			76
C250 	POLIS			✓		77
D400 	POLIS	✓			✓	77



LEGENDA LEGEND



Le caratteristiche indicate possono essere presenti anche solo parzialmente nelle relative serie. Consultare le relative pagine per maggiori dettagli.
The characteristics indicated can be partially present in the relative series. Refer to related pages for details.



2025

info@mcpomicino.com

6

Mario Cirino Pomicino



Telefoni Ufficio 80628 Casa 28488

Telegr. CIRIPOM - NAPOLI C. P. E. Napoli N. 43631



BREVETTO S. A. R. il Duca d'Aosta

FORNITRICE dei RR. Arsenali di Artiglieria e di Marina del Genio Militare e della R. Aeronautica C.C. Postale 6-7547

Ditta Francesca Pomicino & C.

Successore FRANCESCO CIRINO & FIGLI

Casa Fondata Nel 1882

CHIUSINI GHISA - CADITOIE GHISA - FERRAMENTA CHIODERIA - CHINCAGLIERIA - METALLI - UTENSILI IDRAULICA - PESI E MISURE

NAPOLI - Corso Garibaldi 370 e 371 - NAPOLI

AMMINISTRAZIONE E DEPOSITO

Via Caracciolo di Bella (alla Ferrovia) 1 a 17

UNA STORIA DI FAMIGLIA

La Mario Cirino Pomicino SpA, in sigla **®MCP SPA**, vanta una tradizione storica che, a partire dal secolo XIX e precisamente dal lontano 1882, attraversa tre secoli e cinque generazioni.

Sempre in primo piano per caratura e rilevanza della committenza, la **®MCP SPA**, alla fine dell'ottocento, annoverava tra i suoi clienti i "Reali Arsenali delle Forze Armate Italiane". La **®MCP SPA** si è specializzata sin dagli anni '50 nella realizzazione di manufatti in ghisa grigia e dagli anni '90 in quelli in ghisa sferoidale.

Con il socio e amministratore unico Cristiano Cirino Pomicino, l'azienda ha consolidato la continua crescita che l'ha caratterizzata a partire dal 1974, anno di costituzione della presente forma giuridico-societaria di società per azioni, proiettandola ancor più fortemente nel panorama nazionale ed internazionale quale *leader* per la produzione di manufatti in ghisa.

A FAMILY HISTORY

The Mario Cirino Pomicino SpA, or **®MCP SPA**, boasts a historical tradition that has its roots in the 19th century and precisely in the distant 1882.

The Company has always placed a prime role on quality and the importance of the clientele. At the end of the nineteenth century, **®MCP SPA** counted among its customers "Arsenals of the Royal Italian Army". Since the 1950's it has specialized in the manufacturing of grey cast iron products and in the 90's in the manufacturing of those in ductile cast iron.

Five generations have ferried the company, through three centuries constituting it in the current legal and corporate form SpA since 1974, run by the member and sole director Cristiano Cirino Pomicino, under whose guidance, the **®MCP SPA** is consolidated, starting an unstoppable path of growth that has projected it into the national and international scene, becoming a leader in the national market for the production of cast iron products.

MARCHIO STORICO DI INTERESSE NAZIONALE



Casa fondata nel 1882



Mario Cirino Pomicino



Progetto del Ministero dello Sviluppo Economico in collaborazione con Unioncamere volto a inserire le imprese, titolari o licenziatari esclusivi di marchi d'impresa da oltre 50 anni e considerate eccellenze del nostro Paese, in un apposito registro nazionale. L'inserimento della **®MCP SPA** nel Registro Speciale dei Marchi Storici e di Interesse Nazionale (art. 185 bis del D.Lgs. 30/2005) **annovera l'azienda tra quelle che, esulando dall'aspetto meramente economico, hanno contribuito, con la propria storia e il proprio legame col territorio, allo sviluppo nazionale.**

Project of the Ministry of Economic Development in collaboration with Unioncamere aimed at inserting companies, owners, or exclusive licensees of trademarks for over 50 years and considered excellences of our country, in a specific national register. The inclusion of **®MCP SPA** in the Special Register of Historical and National Interest Trademarks (Article 185 bis of Legislative Decree 30/2005) **includes the company among those which, beyond the purely economic aspect, have contributed, with its history and its link with the territory, to national development.**

HISTORY
LA STORIA



MODUS OPERANDI

La [®]MCP SPA, operando in regime di qualità, si propone di fornire ai propri clienti, punto focale della propria attività, i seguenti valori aggiunti:

- Estesa modelliera adeguata alle ultime specifiche esigenze di mercato;
- Possibilità di personalizzazione dei prodotti con loghi/marchi del cliente e/o con l'indicazione dell'uso specifico;
- **Consegna veloce, in Europa anche in 48 ore, per qualsiasi tipologia e quantità richiesta;**
- Elevata specializzazione nel proprio settore derivante da una competenza centenaria;
- Costante risparmio.

MODUS OPERANDI

[®]MCP SPA, operating in a quality system, is committed to providing its Customers with following value added services:

- Wide range of models to choose from, according to the specific market requirement.
- Possibility of products customization with brands/logos and/or indication of the specific use.
- **Express deliveries across all of Europe in less than 48 hours, for any type of items and quantity.**
- High specialization in its sector resulting from decades of experience;
- Constant savings

IL RISPETTO DELLE REGOLE



La [®]MCP SPA, a partire dal lontano 1998, opera in regime di qualità applicando un sistema di gestione aziendale conforme alla norma ISO 9001.

L'ente terzo indipendente Icim Spa - Istituto di Certificazione Industriale per la Meccanica – ha certificato nel medesimo anno la conformità del sistema di gestione della qualità alla normativa di riferimento per le seguenti attività:

“Progettazione e produzione di dispositivi di coronamento e di chiusura per zone di circolazione (chiusini e caditoie) in ghisa grigia e sferoidale. Progettazione e produzione di dispositivi di coronamento, chiusura e di drenaggio, di raccorderia in getti di ghisa, di elementi per il deflusso lineare delle acque in getti di fusione, acciaio zincato e calcestruzzo polimerico.”

Sempre nel 1998 l'ente terzo, accertando il rispetto dei requisiti previsti dallo standard europeo di riferimento, ha certificato i primi lotti di prodotti in ghisa sferoidale conformemente alla norma EN124.

Nel tempo l'attività progettuale e produttiva della società si è diversificata ampliandosi con nuove modellerie di prodotti marcati CE conformemente allo standard EN1433 e certificati dall'ente terzo di riferimento.

Il know-how acquisito nel settore ha portato la [®]MCP SPA alla partecipazione, quale membro tecnico, presso la CEN (Comitato Europeo di Normazione) per la redazione e l'aggiornamento delle norme di prodotto EN124. L'azienda, inoltre, è stata indicata dall'UNI, in qualità di socio, quale esperto tecnico nella composizione dei comitati tecnici finalizzati alla revisione della EN1433.

Le capacità progettuali e produttive si sono espresse compiutamente, nel corso di questi anni, col rilascio di diversi brevetti per le soluzioni innovative apportate in un mercato di cui la [®]MCP SPA detiene la più ampia quota a livello nazionale.

COMPLYING TO STANDARDS



As early as 1998, [®]MCP SPA has implemented a company quality system which complies to ISO 9001 Standard. The Company is certified by an independent body named Icim Spa (Italian Certification Institute for Mechanics) for the following business activities:

“Designing and production of manhole and gully tops (manhole covers and gratings) in grey and ductile cast iron for vehicular and pedestrian areas. Designing and production of manhole, gully and drainage tops, cast iron fittings, linear elements for outflow of water made of cast iron, galvanized steel and polymer concrete”.

During the same year, Icim Spa certified the Company first products, which were designed and manufactured by the Company in compliance with European Standard of Reference EN124. Over time, the Company has varied and expanded its design and production activities with new models equipped with the CE conformity marking and manufactured in compliance with EN 1433 Standard.

Thanks to its specialized know-how, [®]MCP SPA has been appointed as a technical member to participate in the drafting of EN124 Standards at CEN (European Committee for Standardization) and nominated as one of the experts to set up technical panels for the revision of EN1433 Standard.

The design and production skills have been fully expressed during these years, with the release of several patents for innovative solutions in a market where [®]MCP SPA holds the largest share.



2025

info@mcpomicino.com

8



Mario Cirino Pomicino

I NOSTRI CLIENTI E DOVE OPERIAMO

La [®]MCP SPA deve far fronte quotidianamente alle numerose esigenze e richieste dei suoi oltre 30.000 clienti, ed è per questo che il Customer Care Pomicino, un team di esperti, è pronto a fornire adeguate risposte alle svariate domande provenienti da tutto il mondo.

Una capillare rete di rivenditori distribuita sull'intero territorio nazionale ed internazionale e un team di agenti continuamente formati e promuove sul territorio la visibilità dell'azienda anche presso le imprese.

In costante crescita è la fiducia, commerciale e tecnica, risposta nell'azienda da:

- Multi-utility;
- Enti pubblici;
- Grandi gruppi privati;
- Mercati esteri.



MARKETING

Un aggiornamento continuo delle famiglie di prodotti, presentate nelle pubblicazioni annuali che si susseguono e sul sito istituzionale, hanno reso la [®]MCP SPA un riferimento per:

Rivenditori di materiali edili e termoidraulici;

Imprese; Studi di progettazione; Enti; Aziende Municipalizzate; Acquedotti – Gas – Telecomunicazioni – Illuminazione;

Vivai e lattorerie - Impiantisti.

MISSION

La [®]MCP SPA vuole entusiasmare i propri clienti, creando prodotti innovativi, tecnologicamente avanzati e qualitativamente elevati.

Si propone di mantenere la *leadership* nel mercato, di continuare ad essere **punto di riferimento** e di eccellenza per i prodotti in ghisa e, lavorando alla piena soddisfazione del cliente e delle sue aspettative, ricorda che:

“ la parte più preziosa del nostro patrimonio è costituita dai nostri clienti, è quindi nostra costante aspirazione, renderci meritevoli della loro fiducia.”

Mario Cirino Pomicino (1929-2002)

OUR CUSTOMERS

The [®]MCP SPA must cope every day with the many needs and demands of its more than 30,000 customers. That's why was born the Customer Care Pomicino, a team of experts ready to provide adequate answers to the many questions from all over the world.

The figures shown above are based on a turnover made for the 85% from a capillary national and international network of retailers.

A team of highly skilled and trained sales agents daily support the retailers net and promote the visibility of [®]MCP SPA to construction companies on the territory.

The ever-growing technical and commercial trust placed in us, comes also from successful business with:

- multiutilities;
- public bodies;
- private groups;
- foreign markets.

MARKETING

This allows us to unceasingly upgrade our family products as may be seen in the publications and on corporate website which have made [®]MCP SPA a point of reference for:

Retailers of building and thermohydraulic materials; Enterprises; Design studios; Bodies; Public aqueducts - gas - telecommunications - lighting Plant nurseries and tinsmiths; Installers.



MISSION

[®]MCP SPA wants to inspire its customers by designing innovative, high quality and technological products.

The [®]MCP SPA aims to maintain its leadership in the market, to continue to be a reference and excellence point for cast iron products and by ensuring the full customers satisfaction remember that:

“Our most precious assets are our customers, and this is the reason why we continuously strive to deserve their trust.”

Mario Cirino Pomicino (1929-2002)



PERSONALIZZAZIONE DEI PRODOTTI PRODUCT CUSTOMIZATION

La [®]MCP SPA, a richiesta degli acquirenti, personalizza i prodotti con loghi e/o scritte, previa autorizzazione degli enti titolari, **senza ulteriori costi**, anche per **quantità minime**. Offre la possibilità di **verniciare i prodotti** con smalti, anche epossidici, e colori a scelta. Offre, inoltre, la possibilità di realizzare coperchi ventilati su richiesta.

La [®]MCP SPA ha dotato le sue fonderie dei più innovativi sistemi produttivi, ottenendo bassi tempi di produzione ed alti standard qualitativi, unitamente ad un eterogeneo e completo assortimento di prodotti sempre disponibili nei magazzini anche con scritte e/o loghi.

The [®]MCP SPA customizes the products with logos and/or inscriptions, under authorization of the entities, **without any additional costs**, even for **small quantities**.

Possibility to **paint products** with enamels, also epoxy, and in a colour chosen by the client.

Possibility to produce ventilated covers upon request.

[®]MCP SPA provides all its foundries with the most innovative production systems, obtaining reduced production times and high quality standards, together with an heterogeneous and complete range of products available in our warehouses.

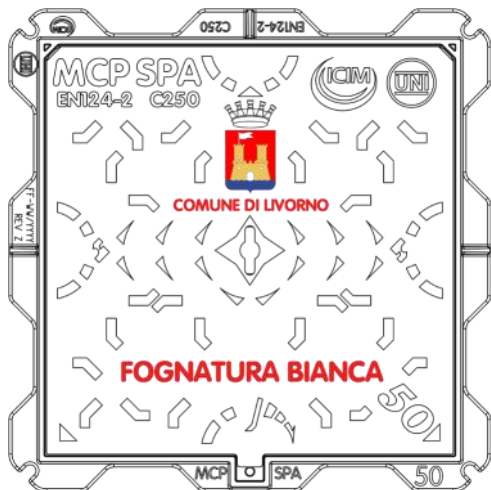

Personalizzazioni per sottoservizi:
Customization for underground utilities:

FOGNATURA

ACQUEDOTTO

PUBBLICA ILLUMINAZIONE

GAS



2025

info@mcpomicino.com

9

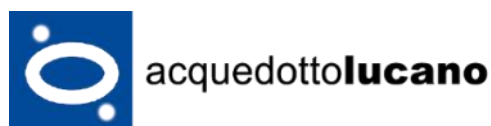

www.mcpomicino.com

ESTRATTO NORMA EN 124

(dispositivi di coronamento e di chiusura per zone di circolazione utilizzate da pedoni e da veicoli)
Marcatura: I coperchi, le griglie ed i telai di chiusini e caditoie in accordo allo Standard Europeo devono essere marcati come segue: **a)** norma (es. EN 124-2); **b)** la classe appropriata (es. D400); **c)** il nome e/o il marchio di identificazione del produttore; **d)** unità produttiva che può essere in codice; **e)** data e/o settimana e anno di produzione (codificata o non codificata);... Tutte le marcature devono, se possibile, essere visibili sul lato superiore dopo l'installazione.

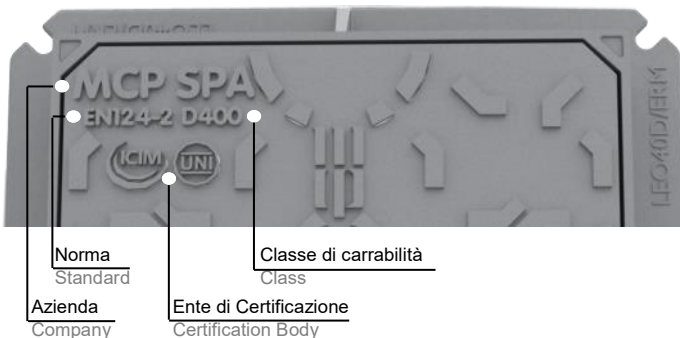

ESTRATTO NORMA EN 1433

(canalette di drenaggio per aree soggette al passaggio di veicoli e pedoni)

Marcatura delle griglie e delle coperture. Griglie e coperture devono essere marcate come segue: **A)** il numero della presente norma, EN 1433 (soltanto se sono soddisfatti tutti i requisiti della presente norma); **B)** la classe appropriata (per esempio D 400); **C)** il nome e/o il marchio di identificazione del produttore della griglia o della copertura, il luogo di produzione che può essere codificato; **D)** il nome e/o il marchio di identificazione del produttore dell'unità grata; **E)** la data di produzione (codificata o non codificata); e possono essere marcate anche con: **F)** marcature aggiuntive correlate all'applicazione prevista da parte dell'utilizzatore; **G)** il marchio di un organismo di certificazione, quando applicabile; **H)** identificazione del prodotto (nome e/o numero di catalogo).

Marcatura dei corpi delle canalette. I corpi delle canalette devono essere marcati come segue: **A)** il riferimento alla presente norma, EN 1433 (soltanto se sono soddisfatti tutti i requisiti della norma); **B)** la classe appropriata (per esempio D 400); **C)** il nome e/o il marchio di identificazione del produttore del corpo delle canalette, che può essere codificato; **D)** il tipo di prodotto (tipo M o tipo I); **E)** la data di produzione (codificata o non codificata); **F)** per le unità canaletta con gradienti incorporati, la sequenza su ciascun elemento; **G)** marcatura relativa al grado di resistenza agli agenti atmosferici per canalette di drenaggio di calcestruzzo (N o W e, se pertinente, +R); **H)** il marchio di un organismo di certificazione, quando applicabile.

STANDARD EN 124 EXTRACT

(gully tops and manhole tops for vehicular and pedestrian areas)
Marking: Covers, gratings and frames of manhole tops and gully tops in accordance with this European Standard shall be marked as follows: **a)** number of this European Standard EN 124-2; **b)** appropriate class (e.g. D400); **c)** name and/or identification mark of manufacturer; **d)** factory of manufacture which may be in code; **e)** date or week and year of manufacture (coded or not coded);... All markings shall, where possible, be visible on the upper side (visible from the trafficked area) after the unit is installed.

STANDARD EN 1433 EXTRACT

(drainage channels for vehicular and pedestrian areas)

Marking of gratings and covers. Gratings and cover shall be marked as follows: **A)** the number of this standard, EN 1433 (only if all the requirements of this standard are met); **B)** the appropriate class (e. g. D 400); **C)** the name and/or identification mark of the manufacturer, of the grating or cover and the place of manufacture which may be expressed in code; **D)** the name and/or identification mark of the manufacturer, of the grid unit; **E)** date of manufacture (coded or not coded); and they may be marked with: **F)** additional markings relating to the intended application of the user; **G)** the mark of a certification body, when applicable; **H)** product identification (name and/or catalogue number).

Marking of channel bodies. Channel bodies shall be marked as follows: **A)** the referente to this standard, EN 1433 (only if all the requirements of this standard are met); **B)** the appropriate class (e. g. D 400); **C)** the name and/or identification mark of the manufacturer of the channel body, which may be expressed in code; **D)** Type of product (Type M or Type I); **E)** date of manufacture (coded or not coded); **F)** for channel units with inbuilt gradiente the sequence on each unit; **G)** marking relating to the degree of weathering resistance for drainage channels made of concrete (N or W, if relevant, + R); **H)** the mark of a certification body, when applicable.

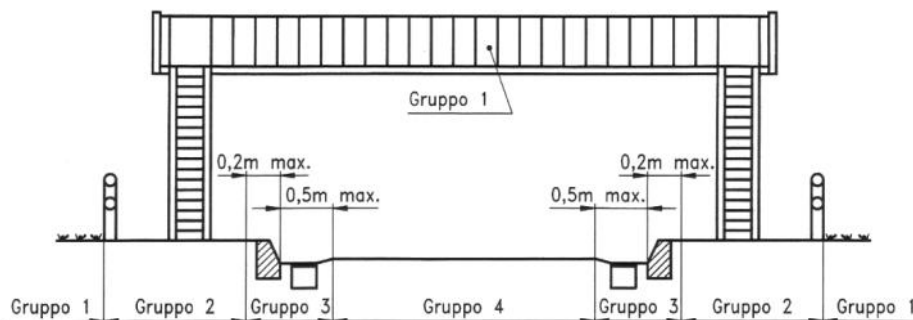

Tipica sezione trasversale di strada con indicazione di alcuni gruppi di luoghi di impiego
 Typical highway cross-section showing the location of some installation groups

GRUPPO 1 - CLASSE A 15
 Chiusini, Caditoie e Griglie con resistenza > 15kN (zone pedonali)
GROUP 1 - CLASS A 15
 Manhole tops and gully tops with loading strength >15kN (Footways)

GRUPPO 2 - CLASSE B 125
 Chiusini, Caditoie e Griglie con resistenza > 125kN (marciapiedi, zone pedonali, aree di parcheggio per automobili)
GROUP 2 - CLASS B 125
 Manhole tops and gully tops with loading strength > 125kN (Footways, pedestrian areas, parking areas)

GRUPPO 3 - CLASSE C 250
 Chiusini, Caditoie e Griglie con resistenza > 250kN (cigli stradali)
GROUP 3 - CLASS C 250
 Manhole tops and gully tops with loading strength > 250kN (Kerbside channels of roads)

GRUPPO 4 - CLASSE D 400
 Chiusini, Caditoie e Griglie con resistenza > 400kN (strade, autostrade, aree di parcheggio)
GROUP 4 - CLASS D 400
 Manhole tops and gully tops with loading strength >400kN (Carriageways, hard shoulders and parking areas)

GRUPPO 5 - CLASSE E 600
 Chiusini, Caditoie e Griglie con resistenza > 600kN (zone portuali, pavimentazione di aeroporti)
GROUP 5 - CLASS E 600
 Manhole tops and gully tops with loading strength > 600kN (Docks, harbour areas, aircraft paving)

GRUPPO 6 - CLASSE F 900
 Chiusini, Caditoie e Griglie con resistenza > 900kN (pavimentazione di aeroporti)
GROUP 6 - CLASS F 900
 Manhole tops and gully tops with loading strength > 900kN (aircraft paving)

NORMATIVA DI RIFERIMENTO

Decreto del Ministro dei lavori pubblici 14 giugno 1989, n. 236

Prescrizioni tecniche necessarie a garantire l'accessibilità, l'adattabilità e la visitabilità degli edifici privati e di edilizia residenziale pubblica, ai fini superamento e dell'eliminazione delle barriere architettoniche.

4.2.2. Pavimentazione.

La pavimentazione del percorso pedonale deve essere antisdrucciolevole. Eventuali differenze di livello tra gli elementi costituenti una pavimentazione devono essere contenute in maniera tale da non costituire ostacolo al transito di una persona su sedia a ruote.

I grigliati utilizzati nei calpestii debbono avere maglie con vuoti tali da non costituire ostacolo o pericolo, rispetto a ruote, bastoni di sostegno, e simili.

(Per le specifiche vedi 8.2.2)

8.2.2. Pavimentazione.

I grigliati inseriti nella pavimentazione devono essere realizzati con maglie non attraversabili da una sfera di 2 cm di diametro; i grigliati ad elementi paralleli devono comunque essere posti con gli elementi ortogonali al verso di marcia.

Decreto del Presidente della Repubblica 24 luglio 1996, n. 503

Eliminazione delle barriere architettoniche in spazi pubblici

Art 4. Spazi pedonali.

Si applicano, per quanto riguarda le caratteristiche del suddetto percorso, le norme contenute ai punti 4.2.2 e 8.2.1, 8.2.2 del DM 14 giugno 1989, n.236

Codice degli Appalti.

Decreto legislativo 12 aprile 2006, n.163

Codice dei contratti pubblici relativi a lavori, servizi e forniture in attuazione delle direttive 2004/17/CE e 2004/18/CE

Art 68. Specifiche tecniche.

(art. 23, dir. 2004/18; art. 34, dir. 2004/17; art. 10 e 11, d.lgs. n.406/1991; art. 8, d.lgs. n. 358/1992; art. 20, d.lgs. n.157/1995; art. 19, d.lgs. n. 158/1995; art.16,co.3, d.P.R. n. 554/1999)

1. Le specifiche tecniche definite al punto 1 dell'allegato VIII, figurano nei documenti del contratto, quali il bando di gara, il capitolato d'oneri o i documenti complementari. Ogni qualvolta sia possibile dette specifiche tecniche devono essere definite in modo da tenere conto dei criteri di accessibilità per i soggetti disabili, di una progettazione adeguata per tutti gli utenti, della tutela ambientale.

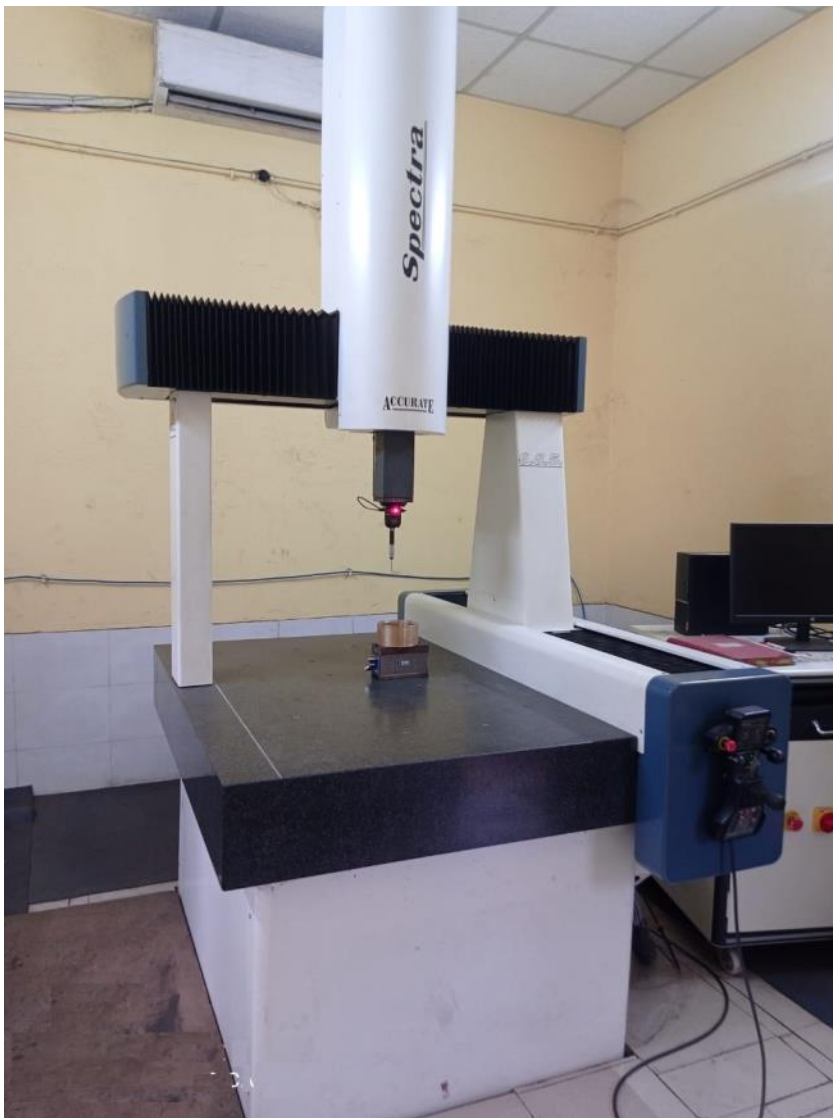

Dal 1998 la **MCP SPA** ha scelto ICIM S.p.A. quale ente terzo indipendente e, annoverandosi tra le aziende certificate per il sistema di gestione qualità, ha ricevuto il Certificato dell'IQNet, The International Certification Network, riconosciuto a livello internazionale.



Since 1998, **MCP SPA** has chosen ICIM S.p.A. as its independent third party and it has been numbered among the companies certified for quality management system. It has been awarded with the IQNet Certificate (The International Certification Network) internationally recognized.

È il più grande network internazionale della certificazione di sistemi di gestione. Associazione internazionale non governativa, IQNET è la rete di organismi di certificazione leader più credibile e affidabile al mondo. Alla **MCP SPA**, poiché certificata ISO 9001:2015 da ICIM Spa (tra gli organismi fondatori del CISQ – unico membro italiano del network IQNet), viene riconosciuto un certificato IQNet, "passaporto internazionale della certificazione" numero di registrazione IT-4220, che attesta il soddisfacimento dei requisiti alla norma di riferimento in ambito internazionale.



IQNET is the largest international network of certification bodies on management system certification as a non-governmental association is the world's most credible and trusted network. To **MCP SPA**, since it is ISO 9001: 2015 certified by ICIM Spa (one of the founding bodies of CISQ) has been recognized by an IQNET certificate (registration number IT-4220) and has the possibility to use the IQNET mark, "international certification passport", that certifies in the international context the fulfillment of the requirements laid down in the reference standard.

ICIM ha diversi anni di esperienza in Qualità, Ambiente, Salute e certificazioni di sicurezza. E' leader nella certificazione di prodotti ed è accreditata per le ispezioni dei prodotti e sistemi volontari.



ICIM has many years of experience in Quality, Environmental, Occupational Health and Safety certifications. It is a leading organisation in the certification of products and it is accredited for product inspections and voluntary schemes.

La **MCP SPA** che negli ultimi 10 anni ha progettato, prodotto e commercializzato oltre 500.000.000 di euro di materiali, ha acquisito un know how tale da essere membro tecnico al CEN (Comitato Europeo di Normazione) per la redazione delle norme di riferimento indicate. È possibile richiedere copia della dichiarazione di prestazione prevista dal regolamento UE n.305/2011, rivolgendosi all'azienda, per i prodotti che rientrano nell'ambito delle norme armonizzate e regolamentate dal documento citato.



MCP SPA has designed, manufactured and marketed over than 500.000.000 Euro of goods in last years, acquiring a know-how such to make it a Technician Member at CEN (European Committee for Standardization) for drafting the reference standards indicated. It is possible to request a copy of performance declaration as provided by the EU regulation n. 305/2011, for those products under the harmonised and regulated standards by the mentioned document.

Accredia è l'Ente Unico nazionale di accreditamento che, operando sotto la vigilanza del Ministero dello Sviluppo Economico e in applicazione del Regolamento europeo 765/2008, attesta la competenza, l'indipendenza e l'imparzialità degli organismi di certificazione, ispezione e verifica, e dei laboratori di prova e taratura. La **MCP SPA** si avvale, per le proprie attestazioni di conformità agli standard di riferimento, dell'ICIM Spa quale ente terzo indipendente legalmente riconosciuto da ACCREDIA.



Accredia is the sole national accreditation body, under the vigilance of the Ministry of Economic Development, in compliance with the application of the European Regulation 765/2008, attesting the competence, independence and impartiality of certification, inspection and verification bodies, as well as testing and calibration laboratories. **MCP SPA** avails of ICIM Spa as an independent third party legally recognized by ACCREDIA for its certificates of compliance with the reference standards.



La ICMQ ha rilasciato alla **MCP SPA** la certificazione di prodotto del contenuto di materiale riciclato/recuperato/sottoprodotto con documento ICMQ n. P578.



The ICMQ has issued the product certification of the quantities of recycled/recovered/by-product material to **MCP SPA** with ICMQ document n. P578.

La certificazione, ai sensi della norma EN14021/2022 – Etichette e dichiarazioni ambientali – Asserzioni ambientali auto-dichiarate (etichettatura ambientale di Tipo II) - **CAM**, attesta la percentuale minima di materiale riciclato utilizzato nella realizzazione dei propri manufatti.



The certification, in accordance with the EN14021/2022 standard - Environmental labels and declarations - Self-declared environmental claims (Type II environmental labeling) - **CAM**, certifies the minimum percentage of recycled material used in the manufacture of its products.



Certificazione Italiana dei Sistemi Qualità Aziendali, è la federazione indipendente che unisce nove dei maggiori organismi di certificazione italiani che operano con specifiche competenze in tutti i settori. CISQ è l'unico membro italiano del network internazionale IQNet. Alla **®MCP SPA**, certificata ISO 9001:2015 da uno degli organismi fondatori di CISQ, viene riconosciuta la validità della certificazione del sistema di gestione aziendale in ambito federativo CISQ – certificato n. 0993/8.



CISQ, that stands for Italian Certification of Quality Management System, is a Federation whose members are eight of the most important Italian Certification Bodies active in all production and services fields. **CISQ** is the only Italian member of IQNET, the largest International Network of Certification Bodies. **®MCP SPA**, has been certified ISO 9001: 2015 by one of the founding bodies of CISQ and has been recognized the validity of the certification of the quality management system in the CISQ federative context - certificate n. 0993/8.

L'Ente nazionale di unificazione UNI svolge l'attività di normazione tecnica in tutti i settori a livello nazionale. Oltre l'elaborazione di nuove norme, in collaborazione con tutte le parti interessate, l'UNI rappresenta l'Italia nelle attività di normazione a livello mondiale (ISO) ed europeo (CEN) allo scopo di promuovere l'armonizzazione delle norme. L'UNI si avvale di aziende, soci UNI, che costituiscono anche il know-how cui riferirsi per la redazione delle norme e di tutti gli aspetti tecnici necessari alla propria attività di standardizzazione e regolamentazione.



The Italian National Unification Body UNI develops and publishes technical standards in all activity sectors at national level. In addition to standardizations made in collaboration with all interested parties, UNI represents Italy in the European standardization organizations (CEN) and worldwide (ISO) in order to promote the harmonization of the standards. Companies that are UNI members, also constitute the know-how to refer to for the drafting of the standards and all the technical aspects necessary for its standardization and regulation activity.

La **®MCP SPA**, quale socio UNI, partecipa, in qualità di membro tecnico, presso il CEN (Comitato Europeo di Normazione) alla redazione e all'aggiornamento delle norme di prodotto EN124 – gruppo di lavoro CEN/TC 165/WG 4. L'azienda, inoltre, è stata indicata dall'UNI quale esperto tecnico nella composizione dei comitati tecnici finalizzati alla revisione della EN1433.



®MCP SPA, as a UNI member, participates at the CEN (European Committee for Standardization), as a technical member for in the drafting and updating of the EN124 product standards - CEN / TC 165 / WG 4 working group. The company has also been indicated by UNI as a technical expert in the composition of the technical committees aimed at revising the EN1433.

La marcatura CE è una procedura obbligatoria per tutti i prodotti da costruzione che sono disciplinati da una direttiva comunitaria. La **®MCP SPA**, per le proprie canalette lineari a norma EN1433, attesta, attraverso la dichiarazione di prestazione DOP, che il suo prodotto è conforme alle prestazioni minime previste dallo standard di riferimento. A ulteriore garanzia dell'utente finale, l'azienda ha sottoposto a certificazione terza indipendente i medesimi prodotti. L' ICIM Spa ha attestato la conformità degli stessi alla norma.



CE marking is a mandatory procedure for all construction products that are governed by a CE directive. **®MCP SPA**, for its linear channels in accordance with EN1433, certifies, through the DOP declaration of performance, that its product complies with the minimum performance required by the reference standard. As a further guarantee for the end user, the company has submitted the same products to independent third party certification. ICIM Spa has certified their compliance with the standard.

L'Agenzia delle Dogane e dei Monopoli ha conferito alla **®MCP SPA** lo status di Operatore Economico Autorizzato – AEO, certificando l'affidabilità e solvibilità dell'azienda nei confronti delle Autorità Doganali Comunitarie e riservandole benefici quali una maggiore velocità nelle spedizioni e migliori relazioni con l'ente.



The Italian Customs and Monopolies Agency has awarded **®MCP SPA** with the status of AEO - Authorised Economic Operator, certifying the reliability and the financial solvency of the company towards EU Customs authorities reserving it benefits such a faster speed in shipments and better relations with the institution.

La vernice usata dalla **®MCP SPA** è priva di sostanze incluse nella lista **Reach**.



The paint used by **®MCP SPA** is free of substances included in the **Reach** list.

La **®MCP SPA**, e i suoi prodotti sono assicurati con **Allianz** di Napoli Plebiscito.



®MCP SPA and our products are insured with **Allianz**.

La **®MCP SPA**, è nel registro delle imprese storiche d'Italia con più di 100 anni.



®MCP SPA is in the accredited in the register of historic companies in Italy with more than 100 years.



LA GHISA SFEROIDALE THE DUCTILE CAST IRON



La ghisa pur avendo una storia millenaria, la ghisa è stata utilizzata per la produzione dei chiusini solo negli ultimi 3 secoli.

Utilizzata prevalentemente nella costruzione di parti meccaniche per le quali necessita la massima resistenza, la **®MCP SPA** è stata, tra i primi in Italia, a credere che la ghisa sferoidale potesse essere il materiale idoneo alla realizzazione di prodotti a norma EN124.

Garanzia di longevità, resistenza, adattabilità geometrica e funzionale sono le caratteristiche più apprezzate di questo materiale utilizzato per realizzare i prodotti che costituiscono il reale *core business* aziendale.

Una produzione massiva di chiusini e caditoie in ghisa sferoidale ha trovato sempre maggior spazio nel mercato di settore a discapito della vecchia "ghisa pesante" o "ghisa grigia".

Lo stesso processo produttivo di questa particolare lega, basato su un controllo rigoroso, garantisce, a differenza della ghisa grigia, costante qualità e ripetibilità in produzione.



The ductile cast iron although the cast iron has a thousand-year history, it has been used for production of manhole covers only since last three centuries.

Ductile cast iron is used to manufacture mechanical parts which demand maximum resistance, **®MCP SPA** were the first in Italy to think that the ductile cast iron would be the material suitable for the manufacturing of products compliant to EN124 standard.

Longevity, strength, and geometric and functional adaptability are most popular features of cast iron, making it ideal to manufacture the **®MCP SPA** products.

Year after year, the mass production of ductile cast iron increasingly replaced the cast iron in the manhole cover market

The production process of this special alloy requires very strict inspections which, in themselves, already ensure unchanging quality.

La norma EN1563 classifica la ghisa sferoidale secondo le caratteristiche meccaniche del materiale.

In particolare la ghisa sferoidale GJS 500-7 deve soddisfare i seguenti requisiti:

The EN 1563 Standard classifies the ductile cast iron according to the mechanical characteristics of the material.

The ductile cast iron GJS 500-7 must satisfy the following requirements:

Resistenza minima a trazione	Carico unitario di scostamento dalla proporzionalità allo 0,2%	Allungamento % min.	Durezza Brinell	Composizione
Tensile Strength	0,2% Proof Stress	Elongation%	Brinell Hardness	Composition
Rm = 500 N/mm ²	Rp.0,2= 320 N/mm ²	Ao= 7	HBS 170÷230	Ferrite+Perlite

Vantaggi dei prodotti in ghisa sferoidale:

• Caratteristiche

I chiusini e le caditoie in ghisa sferoidale vengono progettati in funzione del limite elastico del materiale che viene raggiunto molto prima della rottura, garantendo così un più ampio margine di sicurezza. La norma EN 124 impone non solo il rispetto del carico di prova in relazione alla classe di appartenenza, ma anche la conformità del valore della freccia residua e degli altri requisiti previsti dalla norma.

• Sicurezza

I chiusini e le caditoie in ghisa sferoidale, in caso di eventuale quanto improbabile cedimento, non si rompono in più parti come accade a quelli in ghisa lamellare, ma evidenziano solo delle lesioni assicurando in ogni caso la copertura del pozzetto che diversamente resterebbe sguarnito. La forma sferoidale della grafite produce una minore concentrazione di tensione rispetto a quella lamellare; inoltre la forma sferica è quella che a parità di volume presenta la minore superficie e la matrice della ghisa risulta perciò meno danneggiata riuscendo così a sfruttarne meglio le caratteristiche meccaniche. Inoltre nella ghisa sferoidale i noduli di grafite esercitano un'azione di arresto per le cricche, a differenza della grafite lamellare che offre una via preferenziale per la loro propagazione.

• Maneggevolezza

Le caratteristiche meccaniche della ghisa sferoidale rendono possibile, a parità di resistenza, la realizzazione di strutture più leggere, consentendo anche per modelli di ragguardevoli dimensioni, facilità di posa in opera e manutenzione, nel pieno rispetto delle recenti disposizioni europee (D.Lgs. 81/08 e s.m.i.) sulla sicurezza sul Lavoro.

The advantages of the ductile cast iron products:

• Characteristic

The manhole covers and gratings in ductile iron are designed on the basis of the proof stress of the material that is reached long before the breaking point, thus ensuring a greater margin of safety. The EN 124 standard requires not only the respect of trial load in relation to the loading class, but also the compliance to the value of the permanent set and the other requirements requested by the standard.

• Safety

The manhole covers and gratings in ductile iron, in the unlikely event of any failure, do not break into several parts as it happens to lamellar cast iron ones, but they show only some cracks, ensuring in any case the coverage of the manhole, that otherwise would remain unprotected. The spheroidal graphite produces a lower stress concentration than the lamellar; in addition, since the spherical form has with equal volume a smaller surface as a consequence the cast iron will be less damaged, allowing to better exploit its mechanical features. Furthermore, the graphite nodules into the spheroidal cast iron, exert a stop for the cracks, unlike the lamellar graphite which offers a preferential way for their propagation.

• Handiness

The mechanical properties of ductile iron make possible, keeping the same resistance value, the realization of lighter structures, allowing even for large size models an easy installation and maintenance, in full compliance with the latest European regulations (Legislative Decree no. 81 / 08 as amended) on safety at Work.

Differenza tra ghisa lamellare e ghisa sferoidale Difference between GREY cast iron and ductile iron



info@mcpomicino.com

15

www.mcpomicino.it

POSA IN OPERA CHIUSINI E CADITOIE INSTALLATION MANHOLE TOPS AND GULLY TOPS

POSA CLASSICA

Installazione del telaio sul pozzetto

Prima di iniziare qualsiasi tipo di lavoro, occorre valutare bene il tipo di intervento, ed in particolare considerare quanto segue:

il chiusino o la caditoia deve sempre essere della classe appropriata in funzione del luogo di impiego e, di conseguenza, delle sollecitazioni a cui sarà soggetto/a (secondo quanto indicato dalla UNI EN 124); in caso di dubbio si deve utilizzare un dispositivo della classe superiore a quella strettamente prevista; il telaio del dispositivo deve avere forma simile a quella del pozzetto su cui andrà posato e la dimensione di passaggio deve essere compatibile a quella del pozzetto purché sia garantito il completo appoggio della sua base sulla testa del pozzetto e/o che sia rispettato un valore massimo della pressione di appoggio pari a 7,5 N/mm². Posizionare il telaio sul pozzetto (la dimensione di passaggio del chiusino deve essere ≤ alla dimensione interna del pozzetto) purché sia garantito il completo appoggio della sua base sulla testa del pozzetto e/o che sia rispettato il valore massimo della pressione d'appoggio pari a 7,5 N/mm² - vd UNI/TR 11256) predisponendo una protezione per la parte interna da eventuali sbavature di malta durante la posa. (fig. 1-2-3)

Assicurarsi che la malta cementizia, (composta utilizzando cemento Portland con classe di resistenza a compressione di almeno 50 N/mm² e rispettando i tempi di maturazione prescritti dal produttore), riempia lo spazio sottostante il telaio fino a traboccare dalle asole curando il livellamento del pezzo sulla base di appoggio. Eventuali spessori raggiunti quota devono essere di materiale idoneo all'utilizzo a cui sono destinati, devono avere una resistenza alla compressione minima di 20N/mm² e devono essere inseriti fra la testa del pozzetto e la zona di appoggio del telaio opportunamente conglomerati nel materiale del letto di posa formandone un tutt'uno. Non è ammesso l'uso di mattoni forati, mattonelle e/o piastrelle frantumate, pezzi di legno o di materiale plastico e, comunque, di qualsiasi materiale che non dia le necessarie garanzie di resistenza e durata. Non è ammesso il posizionamento del telaio direttamente sulla testa del pozzetto senza utilizzo della malta cementizia. La malta, durante il riempimento, non deve arrivare al bordo del telaio (almeno 3cm – 4cm prima) in modo da permettere la rifinitura a livello con la stesa del successivo manto bituminoso.(fig.4 e 5)

Nel caso sia necessario operare velocemente, i chiusini/caditoie devono essere collocati su materiali di posa ad indurimento rapido aventi le seguenti caratteristiche minime:

- Granulometria massima 4 mm
- Massa volumica della malta fresca >2100 kg/m³
- Aumento volumetrico in 1gg +0,5 %
- Tempo di lavorabilità ~15 min
- Resistenza alla compressione dopo 30min >1.5 N/mm²
- dopo 1h >8.0 N/mm²
- dopo 24h >35.0 N/mm²
- dopo 28gg >50.0 N/mm²

Resistenza caratteristica a compressione del materiale a fine indurimento 50 N/mm².

Durata e costanza nel tempo delle prestazioni.

Operazioni conclusive

Dopo aver rimosso la protezione per la luce interna del telaio, ripulire da ogni eventuale residuo di malta e bitume le seguenti parti:

- Le superfici di appoggio dei coperchi;
- I vani cerniera dove presenti;
- I vani chiave dove presenti;
- Le guarnizioni interne dove presenti.

Il coperchio/griglia deve essere inserito con cautela nel telaio (ad esempio per mezzo di un dispositivo di sollevamento meccanico o utilizzando chiavi di sollevamento) solo dopo che il materiale abbia fatto una sufficiente presa e resistenza alla compressione, per non comprometterne il corretto posizionamento. (fig. 4). Prima di rendere transitabile il chiusino/caditoia rispettare i tempi di maturazione forniti dal produttore del cemento e in mancanza d'indicazioni rispettare un tempo di attesa di almeno 72 ore.

Note

L'utilizzo delle malte deve avvenire seguendo le istruzioni del fabbricante del prodotto (dosaggio, rapporto acqua/cemento, posa in opera, tempi di maturazione). Rispettare il tempo minimo di maturazione della malta prima di sollecitare il chiusino con i carichi di esercizio. Il tempo minimo è in funzione della temperatura e del grado di umidità. Evitare il contatto diretto fra i dispositivi di compattazione ed il chiusino/caditoia per evitare possibili danni al telaio, al coperchio/griglia e allo strato del letto di posa.

Si raccomanda l'uso di chiusini in classe D400 per i massetti industriali. Effettuare il getto del massetto con il chiusino posato nell'unità completa. Proteggere il prodotto dai carichi fino all'ultimazione dei lavori/pavimentazioni con una piastra in acciaio.

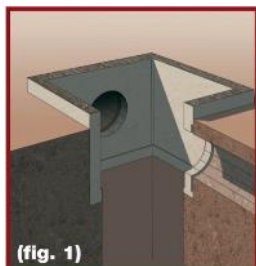

(fig. 1)

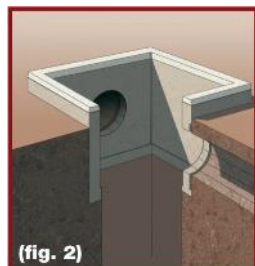

(fig. 2)



(fig. 3)

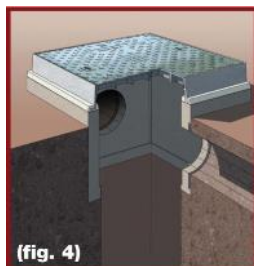

(fig. 4)

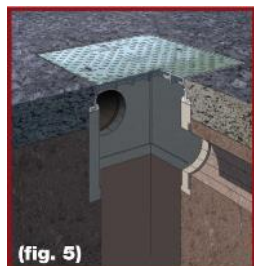

(fig. 5)

TIPYCAL INSTALLATION

Frame installation

Before starting any kind of work, it is necessary to deeply evaluate the nature of intervention, especially taking into account what follows:

the manhole cover or the gully top must always belong to the proper class based on the place of use and, as a consequence, based on the stress it will endure, (in compliance with UNI EN 124); when in doubt, a product of superior class than the one strictly provided by the standard shall be used; the frame must have similar shape to the one of manhole on which the it will be installed and the clear opening must be compatible with the one of the manhole, provided that its full base will be guaranteed to be laid on the head of the manhole and/or provided that the maximum value of the pressure on the support in the amount of 7,5 N/mm² (UNI/TR 11256) will be respected.

The frame must be placed on the well (the clear opening must be ≤ of the internal dimension of the well).

The complete support of the frame on the well must be assured and the value of 7.5 N/mm² as maximum value of the supporting pressure must be respected.

There must be a protection of the internal part of the frame from alien materials. (pic. 1-2-3)

Do make sure that the mortar cement, (composed of PORTLAND cement – min. stress 50N/mm², and complying the curing times stated by the producer), always fill the area below the frame covering the frame slots and paying attention to the levelling of the frame on the supporting surface.

Possible shims utilized to reach the level must be of appropriate material; and must have compression strength no lower than 20N/mm² and must be placed between the frame and the edge of the well duly combined with the filling material.

The utilization of air bricks, squares and/or crushed tiles, wooden or plastic pieces and any other material without the necessary features of strength and durability, is not allowed.

The filling mortar must remain below the edges of the frame (3-4 cm below at least) in order to enable the levelling refinement through a layer of bitumen. (pic. 4-5)

If a faster operation is needed, rapid hardening materials are requested, having the following minimum features:

- Max granulometry mm 4
- Specific weight of the fresh mortar >2100kg/m³
- Volume increase in 1 day +0,5%
- Workable time ~15 minutes
- Compression strength after 30 minutes >1.5 N/mm²
- after 1 h >8.0 N/mm²
- after 24 h >35.0 N/mm²
- after 28 days >50.0 N/mm²

Compression strength (hardened) 50 N/mm².

Performance durability and constancy.

Final operations

After removing the protection from the internal side of the frame, clean the following parts to eliminate mortar and bitumen residuals:

- Cover supporting surface
- Hinge housing, if available
- Key housing, if available
- Internal gaskets, if available.

The cover/grate must be carefully placed in the frame (e.g.. by using a lifting mechanical system or by the lifting keys) only after the material has settled and has achieved a sufficient compression strength, in order not to compromise the correct positioning. Do not allow to pass through manhole/gully tops before the curing time stated by the cement producer has passed. Do wait 72 hours in case no time has been indicated.

Remarks

Mortars must be used according to the manufacturer's instructions (dosage, water/cement ratio, laying, curing time). The minimum curing time must be respected before stressing the device with the working loads. The minimum curing time depends upon temperature and degree humidity. The direct contact between the compacting tools and the device must be avoided to impede possible damages to the device and the laying bed.

It is recommended the use of manhole covers class D400 for industrial screeds. The screed must be laid when the manhole top is placed onto the whole section.

Protect the product from the loads until the work/flooring is completed with a steel plate.

Il mancato rispetto delle istruzioni di posa, specificate nel documento UNI/TR 11256, esonera la [®]MCP SPA da qualsiasi responsabilità, anche verso terzi.



The inobservance of the installation instructions, listed into UNI/TR 11256 document, relieves [®]MCP SPA from any kind of responsibility, third parties included.

POSA IN OPERA CHIUSINI E CADITOIE INSTALLATION MANHOLE TOPS AND GULLY TOPS



POSA MASSETTO INDUSTRIALE

Installazione del telaio sul pozzetto

Per la posa nei massetti industriali si raccomanda l'uso dei prodotti in classe D400.

Il telaio del dispositivo deve avere forma simile a quella del pozzetto su cui andrà posato e la dimensione di passaggio deve essere compatibile a quella del pozzetto purché sia garantito il completo appoggio della sua base sulla testa del pozzetto e/o che sia rispettato un valore massimo della pressione di appoggio pari a 7,5 N/mm².

Effettuare il getto del massetto con il chiusino/caditoia nell'unità completa. Si raccomanda l'utilizzo di almeno 2 distanziatori a croce per ogni lato nel gioco tra coperchio e telaio per ridurre la spinta del calcestruzzo sul prodotto in fase di getto. (fig. 6 e 7)

Successivamente, qualora sia previsto l'uso della lucidatrice, estrarre il coperchio dal telaio per le operazioni di rifinitura del massetto.

Nel caso la finitura debba essere eseguita con il coperchio/griglia posato si raccomanda di evitare il passaggio della lucidatrice sul coperchio/griglia durante l'operazione.



fig. 6 / pic. 6



fig. 7 / pic. 7

Note

I coperchi e le griglie **non sono intercambiabili** pertanto, durante le operazioni di movimentazione e di posa, si raccomanda di associare ad ogni telaio il rispettivo coperchio/griglia per evitare il successivo montaggio in telai differenti da quelli ricevuti nell'unità completa.

INSTALLATION ON INDUSTRIAL SCREEDS

Frame installation

D400 class products are recommended for installation in industrial screeds. The frame must have similar shape to the one of manhole on which it will be installed and the clear opening must be compatible with the one of the manhole, provided that its full base will be guaranteed to be laid on the head of the manhole and/or provided that the maximum value of the pressure on the support in the amount of 7,5 N/mm² (UNI/TR 11256) will be respected.

The pouring of the screed must be done with the manhole cover/gully top fully assembled.

It is recommended to use at least 2 tile spacers for each side between the cover and frame to avoid any eventual deformation of the frame during the concrete pouring (pic. 6 - 7).

If the use of a screed polisher is needed, the cover / grate must be taken out before the finishing operations, in case it is needed to keep the cover / grate installed, it must be avoided to go over it.

Notes

The covers and grids are not interchangeable, therefore during handling and installation operations, **it is recommended to associate the respective cover/grid with each frame** to avoid subsequent assembly in frames different from those received in the complete unit.

POSA IN OPERA CANALETTE INSTALLATION DRAINAGE CHANNELS

Il corpo canaletta e la spalletta in calcestruzzo devono formare un'unica struttura per resistere alle sollecitazioni esterne dovute al traffico. Verrà qui di seguito esposto il dimensionamento della spalletta per una corretta posa in opera delle canalette, facendo riferimento ai risultati di test effettuati nei laboratori di prova notificati a livello europeo.

Lo scavo, che ospiterà le canalette, dovrà essere realizzato considerando le dimensioni totali date dalla larghezza del corpo canaletta più le dimensioni previste per il getto di rinforzo in calcestruzzo secondo quanto specificato dallo schema in figura.

Nello schema sono descritte le dimensioni delle spallette in calcestruzzo da utilizzare affinché il corpo unico canaletta e la spalletta resista al carico previsto in funzione della classe di carrabilità.

Utilizzare un calcestruzzo con caratteristiche meccaniche \geq a Rck 300.

Una volta realizzato lo scavo, si getta il calcestruzzo a formare un letto di posa su cui verranno disposte le canalette.

Si consiglia di unire i corpi canaletta con silicone acetico nel caso di deflusso di acque reflue o con adesivo poliuretano nel caso di deflusso di derivati del petrolio per assicurare, in entrambi i casi, la tenuta ai liquidi.

Solo successivamente si completa il getto in calcestruzzo realizzando le spallette come descritto nello schema.

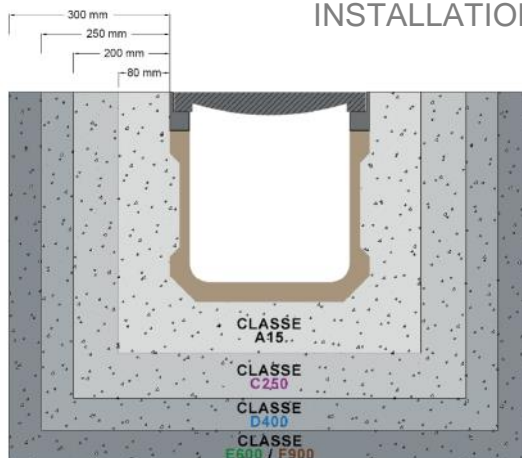

The body and the concrete side must constitute a single structure capable of enduring all traffic loads. The method and dimensioning for a right installation that we describe below, have been duly evaluated by several tests, performed in laboratories recognized at European level.

The dimensions of trench for the channels housing must be calculated by adding the external dimensions of the channel's body to the measures of the concrete casting as per scheme in picture.

Such a scheme shows the dimensions of the concrete side to be utilized in order to ensure that the single structure (channel + side) is able to withstand the loads of the related classes. The concrete must have mechanical features \geq Rck 300.

After the trench's realization, the concrete must be laid to form a surface on which the channels

will be placed.

For the jointing, the following materials are suggested:

- channels for water outflow: acetic silicon;
- channels for petrol derivatives: polyurethane adhesive.

Finally the concrete casting will be completed by realizing the two sides as described in picture.

MANUTENZIONE MAINTENANCE

La opportuna manutenzione dei dispositivi ne garantisce l'utilizzo alle condizioni ottimali.

Nel merito raccomandiamo le seguenti attività:

- ⇒ estrarre completamente il coperchio dal telaio prima di compiere qualsiasi operazione;
- ⇒ verificare con frequenza i sistemi di chiusura-bloccaggio e gli alloggiamenti dei vani cerniera ideati per realizzare l'estrazione ed il blocco di sicurezza dei coperchi nella posizione di apertura;
- ⇒ controllare periodicamente, in relazione alle sollecitazioni di esercizio, le guarnizioni, ove previste e procedere, se necessario, alla loro sostituzione;
- ⇒ pulire le sedi di appoggio dei coperchi e delle griglie e saturarle di grasso in occasione di ogni singola apertura.

The appropriate maintenance of the devices assures the use at its best conditions.

For this purpose we recommend the following operations:

- ⇒ take off the cover before starting any kind of work;
- ⇒ frequent control of the locking-securing devices and of the hinge housings designed to enable the extraction and the safety tightening of the covers position;
- ⇒ periodical control of the gaskets, if existing, in relation with the working stresses and replace it if necessary;
- ⇒ clean the seating of covers and gratings, and fill with grease after each single opening.

I prodotti in classe D400 non sono adatti ad aree soggette a veicoli con pneumatici pieni o sospensioni non pneumatiche tipo carrelli elevatori o simili.



The D400 products are not suitable for areas subject to vehicles with solid tyres or non-pneumatic suspension such as forklift trucks.

ISTRUZIONI PER L'USO

INSTRUCTION FOR USE

MODELLI CON SISTEMA DI APERTURA AUTOMATICA
 MODELS WITH AUTOMATIC OPENING SYSTEM

- ◆ RAFFAELLO (D400)
- ◆ SPARTAN
- ◆ COLOSSUS
- ◆ LEONARDO
- ◆ MICHELANGELO STEADY POWER



Inserire una leva (leverino o piede di porco) nell'apposito alloggiamento posto sul bordo del coperchio (fig. 1) e fare leva verso il basso fino allo sblocco del sistema di chiusura (fig. 2). Inserire la leva nell'altra asola cieca per il ribaltamento del coperchio (fig. 3). Per la chiusura imprimere una forza necessaria sul sistema di chiusura fino al blocco dello stesso. Per l'apertura del chiusino è necessario lasciare l'area di manovra della leva di sblocco libera da ostacoli.

Insert a lever into the provided slot on the side of the cover (pic. 1) and push the lever down until it unlocks the locking system (pic. 2). Insert the lever into the blind slot for tipping the cover up (pic. 3). To close, give the necessary strength on locking system to lock it. To perform the opening of the device it is necessary to keep enough room for the unlocking operation.

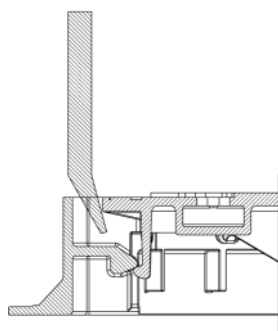
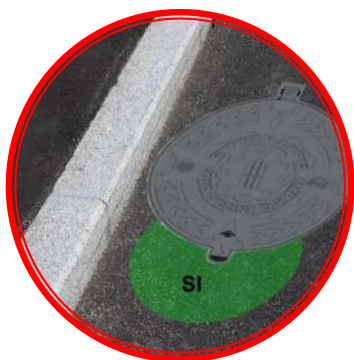

fig. 1
pic. 1

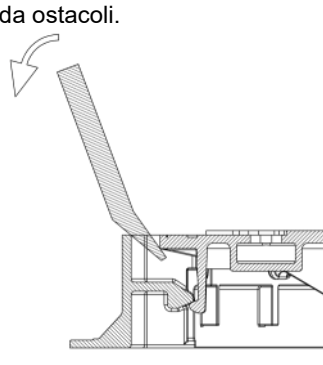

fig. 2
pic. 2

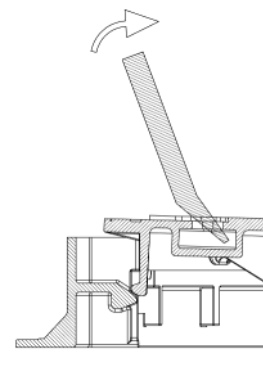

fig. 3
pic. 3

info@mcpomicino.com

18

- ◆ GIORDANO
- ◆ DE CHIRICO

Inserire una leva (leverino o piede di porco — fig. 1 e fig. 2) nell'apposita asola cieca posta sul coperchio ed imprimere uno sforzo in direzione della cerniera del chiusino per procedere alla apertura (fig. 3). L'operazione inversa determina la chiusura del coperchio.

Insert a lever (pic. 1 and pic. 2) in the proper blind slot located on the cover and push in direction of the hinge to open it (pic. 3). The reverse operation causes the cover to close.

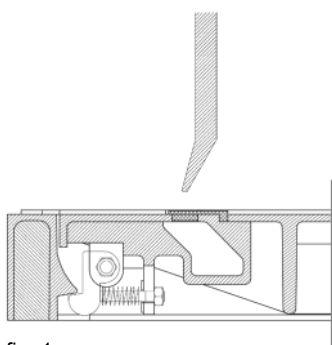

fig. 1
pic. 1

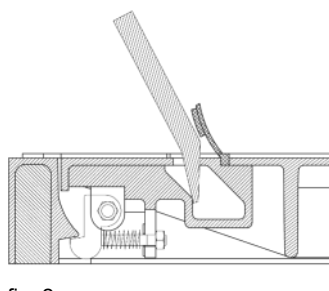

fig. 2
pic. 2

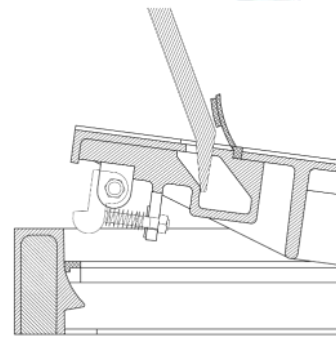

fig. 3
pic. 3

Rimuovere completamente il coperchio prima di compiere qualsiasi lavoro.



Take off the cover before starting any kind of work.

- ◆ TELEFONIA
- ◆ GIOTTO
- ◆ TINTORETTO
- ◆ RAFFAELLO (E600/F900)



PREZZO NETTO:
4,00 € CAD.
NET PRICE:
4,00 € EACH

Inserire l'utensile chiave nell'apposita asola posta sul coperchio fino al raggiungimento della boccola del sistema di chiusura. (fig. 1)

Ruotare la chiave di 90° per consentire lo sblocco del sistema di chiusura e sollevare il coperchio. (fig. 2)

L'operazione inversa determina la chiusura del coperchio.

Insert the key-tool in the proper hole on the cover until the locking device is reached. (pic. 1)

Turn the key to 90° to enable the un-locking of the system and lift the cover up. (pic. 2)

The reverse operation causes cover to close.

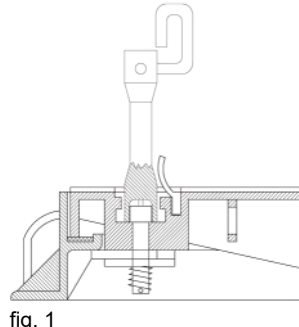

fig. 1
pic. 1

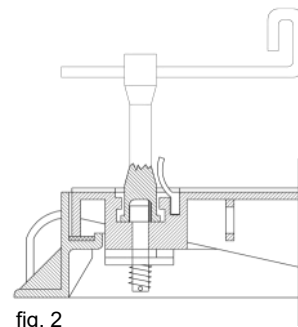
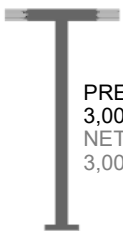

fig. 2
pic. 2

- ◆ RAFFAELLO (E600)
- ◆ MODIGLIANI
- ◆ LEONARDO T. STAGNA
- ◆ HIDRO



PREZZO NETTO:
3,00 € CAD.
NET PRICE:
3,00 € EACH

Inserire l'utensile chiave nell'apposita asola posta sul coperchio fino al raggiungimento della boccola esagonale del sistema di chiusura. (fig. 1) Ruotare la chiave di 90° per consentire lo sblocco del coperchio (fig. 2). Inserire la chiave di sollevamento (fig. 3) nell'asola cieca posta sul coperchio e ruotarla di 90° (fig. 4).

Sollevare il coperchio (fig. 5). L'operazione inversa determina la chiusura del coperchio.

Insert the key-tool in the proper hole on the cover until the hexagon socket of the locking system is reached. (pic. 1)

Turn the key to 90° to enable the un-locking of the cover (pic. 2). Insert the lifting key (pic. 3) in the blind slot located on the cover and turn it 90° (pic. 4).

Lift the cover up (pic. 5). The reverse operation causes the cover to close.

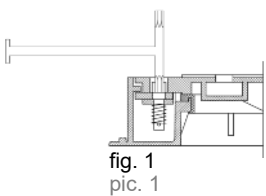

fig. 1
pic. 1

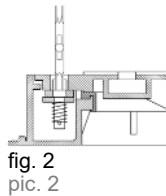

fig. 2
pic. 2

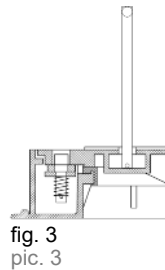

fig. 3
pic. 3

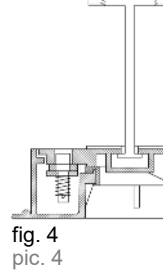

fig. 4
pic. 4

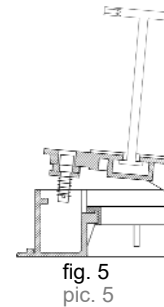
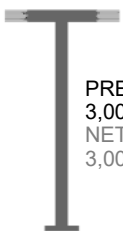

fig. 5
pic. 5

- ◆ ALTRE SERIE



PREZZO NETTO:
3,00 € CAD.
NET PRICE:
3,00 € EACH

Inserire l'utensile chiave nell'apposita asola cieca posta sul coperchio. (fig. 1)

Ruotare l'utensile di 90° (fig. 2) che per la particolare estremità a forma di croce, arpiona il coperchio consentendone il sollevamento e l'estrazione. (fig. 3)

L'operazione inversa determina la chiusura del coperchio.

Insert the key tool in the proper blind hole located on the cover. (pic. 1) Rotate the key tool to 90° (pic. 2) to hook the cover and to enable its lifting. (pic. 3)

The reverse operation causes the cover to close.

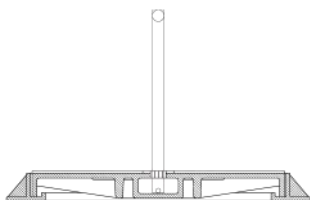

fig. 1
pic. 1

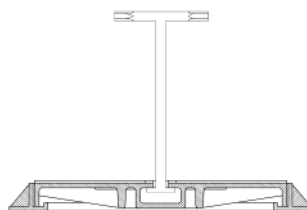

fig. 2
pic. 2

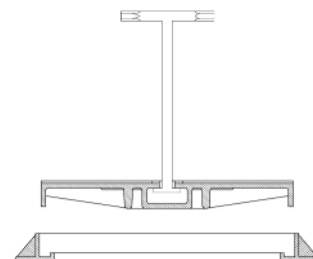

fig. 3
pic. 3

La [®]MCP SPA partecipa alle più importanti fiere mondiali del settore.

La presenza consente un contatto diretto con gli operatori e permette di adeguare la produzione alle crescenti necessità di mercato.



The [®]MCP SPA attends at the most important international trade fairs of the sector.

The participation guarantees direct contact with all the operators and the adaptation of the production to the growing needs of the market.

- SAIE
- H2O
- MADE
- IFAT

info@mcpomicino.com

20



La comunicazione è sempre stata fondamentale nella storia della [®]MCP SPA.

Sempre attenta alle evoluzioni delle varie forme d'informazione, l'azienda ha nel corso degli anni caratterizzato e perfezionato il suo messaggio.



Communication has always been important in the history of the [®]MCP SPA.

Always attentive to the evolution of the various forms of information, the [®]MCP SPA, has over the years characterized and refined its message.

ATTIVITA' FIERISTICA
EXHIBITION ACTIVITY

DA SEMPRE SULLE NOSTRE STRADE.
FOR A LONG TIME ON OUR STREETS.



CHIUSINI IN GHISA SFEROIDALE



DUCTILE CAST IRON MANHOLE TOPS



TAMPONS D'ÉGOUT IN FONTE DUCTILE



SCHACHTABDECKUNGEN AUS DUKTILEM GÜBEISEN



TAPS EN FUNDICIÓN DÚCTIL



Designed by MCP SPA® in Italy



2025

LEONARDO ERMETICO ICON



Chiusini in ghisa sferoidale
Ductile cast iron manhole tops



LEO50B/IC

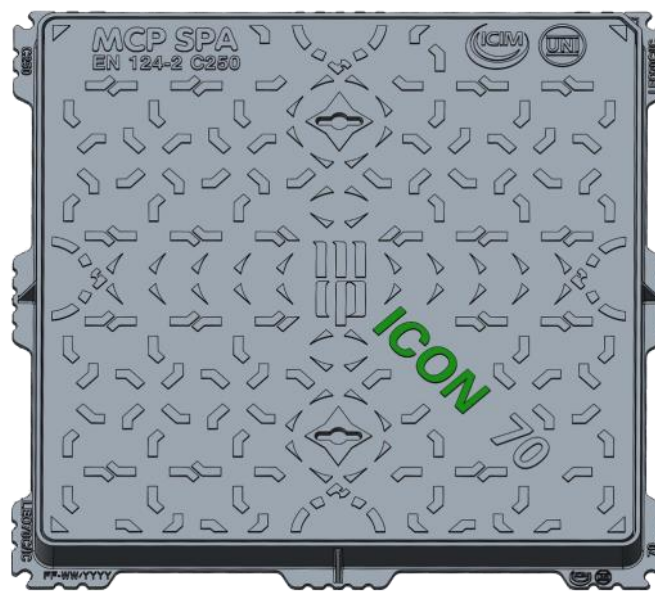

LEO70C/IC

22



CODICE	CLASSE	DIMENSIONI ESTERNE	LUCE NETTA	ALTEZZA	PESO TOTALE	PEZZI PER PEDANA	NOTE	LISTINO
CODE	CLASS	EXTERNAL DIMENSIONS	CLEAR OPENING	HEIGHT	TOTAL WEIGHT	PIECES ON PALLET	NOTES	PRICE LIST
		mm	mm	mm	Kg.	n.		€
LEO20B/IC	B125	200X200	140X140	25	3	300		30,00
LEO30B/IC	B125	300X300	200X200	30	4,8	48		45,00
LEO40B/IC	B125	400X400	300X300	30	8	48		62,00
LEO50B/IC	B125	500X500	400X400	30	12,2	20		99,00
LEO55B/IC	B125	550X550	450X450	35	16,5	20		139,00
LEO60B/IC	B125	600X600	500X500	35	19	20		149,00
LEO70B/IC	B125	700X700	600X600	40	28,5	20		229,00
LEO80B/IC	B125	800X800	700X700	45	40,5	16		324,00
LEO90B/IC	B125	900X900	800X800	55	50	16		454,00
LEO100B/IC	B125	1000X1000	900X900	60	81	12		669,00

CODICE	CLASSE	DIMENSIONI ESTERNE	LUCE NETTA	ALTEZZA	PESO TOTALE	PEZZI PER PEDANA	NOTE	LISTINO
CODE	CLASS	EXTERNAL DIMENSIONS	CLEAR OPENING	HEIGHT	TOTAL WEIGHT	PIECES ON PALLET	NOTES	PRICE LIST
		mm	mm	mm	Kg.	n.		€
LEO30C/IC	C250	300X300	200X200	30	6	48		55,00
LEO40C/IC	C250	400X400	300X300	35	10,5	48		80,00
LEO50C/IC	C250	500X500	400X400	40	16	20		128,00
LEO55C/IC	C250	550X550	450X450	45	21	20		169,00
LEO60C/IC	C250	600X600	500X500	45	24	20		192,00
LEO70C/IC	C250	700X700	600X600	50	36	18		282,00
LEO80C/IC	C250	800X800	700X700	55	46	15		393,00
LEO90C/IC	C250	900X900	800X800	65	59	12		544,00
LEO100C/IC	C250	1000X1000	900X900	70	95	8		838,00

Disponibilità immediata con le seguenti personalizzazioni:
Immediate availability with the following customization:

FOGNATURA
PUBBLICA ILLUMINAZIONE

ACQUEDOTTO
GAS



Certificazioni
Certifications

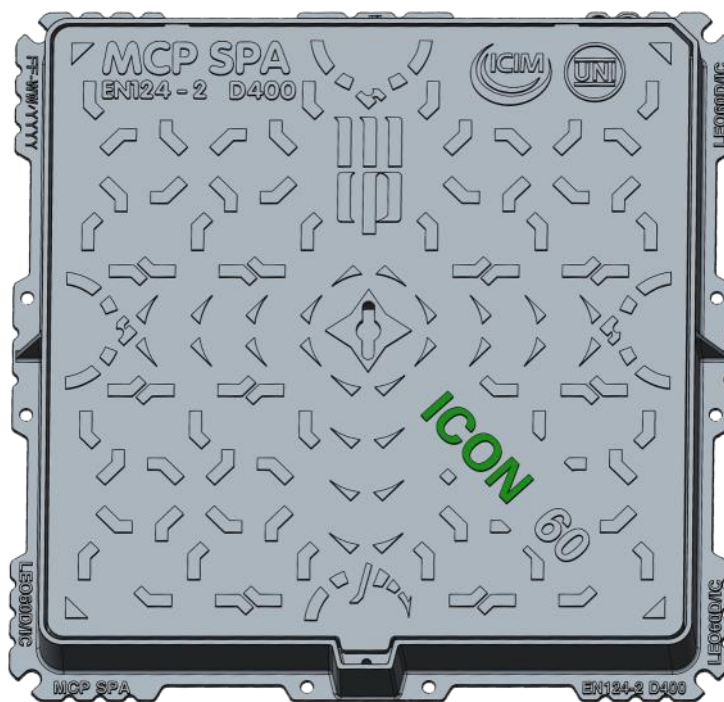

LEO60D/IC



D400 CON CHIUSURA AUTOMATICA

CODICE CODE	CLASSE CLASS	DIMENSIONI ESTERNE EXTERNAL DIMENSIONS mm	LUCE NETTA CLEAR OPENING mm	ALTEZZA HEIGHT mm	PESO TOTALE TOTAL WEIGHT Kg.	PEZZI PER PEDANA PIECES ON PALLET n.	NOTE NOTES	LISTINO PRICE LIST €
LEO40D/IC	D400	400X400	270X270	75	15,5	24		124,00
LEO50D/IC	D400	500X500	400X400	75	24	20		193,00
LEO55D/IC	D400	550X550	450X450	75	30	20		240,00
LEO60D/IC	D400	600X600	500X500	75	33,5	20		266,00
LEO70D/IC	D400	700X700	600X600	75	46	10		378,00
LEO80D/IC	D400	800X800	700X700	75	54	10		517,00
LEO90D/IC	D400	900X900	800X800	75	80	10		692,00
LEO100D/IC	D400	1000X1000	900X900	80	116	8		948,00
LEO110D/IC	D400	1100X1100	1000X1000	80	135	6		1.108,00
LEO120D/IC	KN400	1200X1200	1100X1100	80	168	5		1.398,00

 **i** NON PREVISTO DALLA NORMA EN124
i NOT INCLUDED IN EN124 STANDARD



BULLONATO

**NEW
PRODUCT**

CODICE CODE	CLASSE CLASS	DIMENSIONI ESTERNE EXTERNAL DIMENSIONS mm	LUCE NETTA CLEAR OPENING mm	ALTEZZA HEIGHT mm	PESO TOTALE TOTAL WEIGHT Kg.	PEZZI PER PEDANA PIECES ON PALLET n.	NOTE NOTES	LISTINO PRICE LIST €
LEO135D/IC	KN400	1350X1350	1200X1200	100	207	2	CON BULLONI WITH BOLTS	1.840,00

 **i** NON PREVISTO DALLA NORMA EN124 E DA 4 VITI IN ACCIAIO INOX DN 10
i NOT INCLUDED IN EN124 STANDARD AND 4 SCREWS IN STAINLESS STEEL DN 10

Disponibilità immediata con le seguenti personalizzazioni:
 Immediate availability with the following customization:

FOGNATURA
PUBBLICA ILLUMINAZIONE

ACQUEDOTTO
GAS

enel open fiber TIM

Chiusini in ghisa sferoidale
Ductile cast iron manhole tops

23



Certificazioni
Certifications



2025

Chiusini in ghisa sferoidale
Ductile cast iron manhole tops

LEONARDO ICON Tenuta Stagna

**NEW
PRODUCT**

CARATTERISTICHE:

- ⇒ Carico di rottura > 400kN
Breaking load > 400kN
- ⇒ Telaio con battuta interna "U" per l'ermeticità agli odori.
Frame with "U" shaped internal seating for airtight.
- ⇒ Aletta perimetrale esterna, continua sui quattro lati del telaio, per una maggiore base di appoggio e un migliore ancoraggio alla fondazione.
Continuous outer winglet along the four sides for a greater supporting base and a better anchorage to the foundation.
- ⇒ Identificazione dimensionale del prodotto.
Identification of the product size.
- ⇒ Fissaggio del coperchio con bulloni.
Cover fixing with bolts.

CODICE	CLASSE	DIMENSIONI ESTERNE	LUCE NETTA	ALTEZZA	PESO TOTALE	PEZZI PER PEDANA	NOTE	LISTINO
CODE	CLASS	EXTERNAL DIMENSIONS	CLEAR OPENING	HEIGHT	TOTAL WEIGHT	PIECES ON PALLET	NOTES	PRICE LIST
		mm	mm	mm	Kg.	n.		€
LEO50D/IC/WT	D400	490X490	390X390	75	30	20	TENUTA STAGNA WATERTIGHT	274,00
LEO60D/IC/WT	D400	590X590	490X490	75	39	20	TENUTA STAGNA WATERTIGHT	356,00
LEO70D/IC/WT	D400	690X690	600X600	75	52	10	TENUTA STAGNA WATERTIGHT	475,00

24

LEONARDO ERMETICO ICON F900

**NEW
PRODUCT**

CARATTERISTICHE:

- ⇒ Carico di rottura > 900kN
Breaking load > 900kN
- ⇒ Telaio con battuta interna "U" per l'ermeticità agli odori.
Frame with "U" shaped internal seating for airtight.
- ⇒ Aletta perimetrale esterna, continua sui quattro lati del telaio, per una maggiore base di appoggio e un migliore ancoraggio alla fondazione.
Continuous outer winglet along the four sides for a greater supporting base and a better anchorage to the foundation.
- ⇒ Identificazione dimensionale del prodotto.
Identification of the product size.

CODICE	CLASSE	DIMENSIONI ESTERNE	LUCE NETTA	ALTEZZA	PESO TOTALE	PEZZI PER PEDANA	NOTE	LISTINO
CODE	CLASS	EXTERNAL DIMENSIONS	CLEAR OPENING	HEIGHT	TOTAL WEIGHT	PIECES ON PALLET	NOTES	PRICE LIST
		mm	mm	mm	Kg.	n.		€
LEO70F/IC	F900	735X735	600X600	100	84	10		766,00
LEO80F/IC	F900	820X820	690X690	100	104	10		949,00
LEO90F/IC	F900	900X900	790X790	100	124	10		1.131,00

**PER ZONE PARTICOLARI (AEROPORTI—PORTI—ZONE INDUSTRIALI).
FOR PARTICULAR AREAS (AIRPORTS—PORTS—INDUSTRIAL AREAS).**

Certificazioni
Certifications

PER LA SERIE LEONARDO

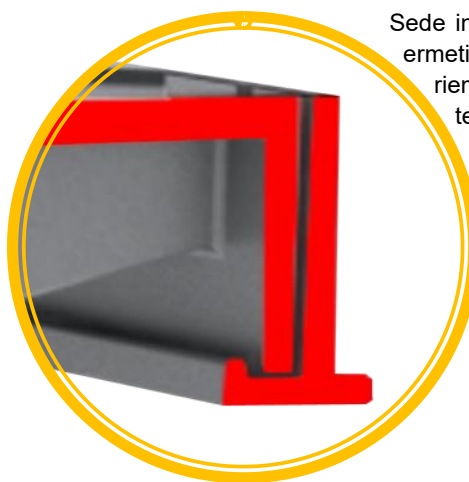

Sede interna a "U" per ottenere la ermeticità agli odori mediante riempimento di sabbia e/o materiali equivalenti in accoppiamento col coperchio. Telaio con canaletta interna di appoggio del coperchio continua, senza interruzioni per tenuta ermetica.

ERMETICITA' AIRTIGHT



"U" shaped internal seat to achieve the air-tightness to odors by filling with sand and/or equivalent materials when coupled with the cover. Continuous inner edge of the frame with "U" shape for sealing purposes.

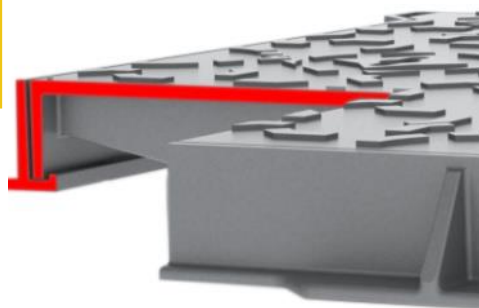

Chiusini in ghisa sferoidale
Ductile cast iron manhole tops

25



Certificazioni
Certifications



La MCP SPA ha applicato il sistema di vincolo anche ai prodotti in classe **B125** poiché posizionati nelle aree di più facile accesso ai bambini (marciapiedi, aree pedonali,...). L'azienda ha, così, ampliato i principi di sicurezza presenti nella norma per le persone ritenute più vulnerabili e per le zone di maggiore utilizzo prevenendo la rimozione non autorizzata del coperchio a mezzo di sistemi di bloccaggio.



SICUREZZA SAFETY



MCP SPA applied the constrained cover system also to class **B125** products as installed in those areas that are easy accessible by children (as sidewalks, pedestrian areas ...). In this way it has been enhanced the safety guidelines provided by the EN124 rules for those people considered most vulnerable and for the areas with higher utilization rate by dissuading the opening of the cover by means of locking systems.

VINCOLO CONSTRAINED COVER



Incastro anti-sfilamento del coperchio per il posizionamento univoco all'interno del telaio.

Anti-extraction constrained cover, shaped for unique matching position in its frame.

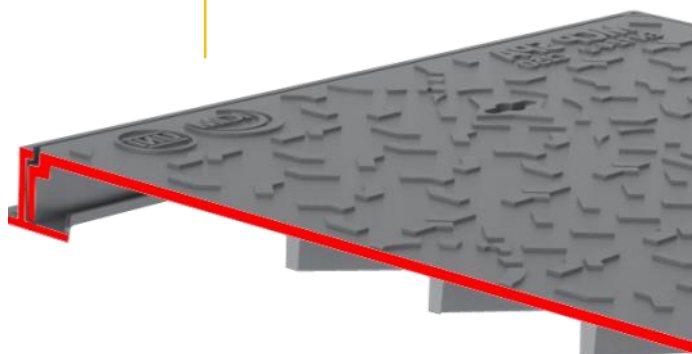
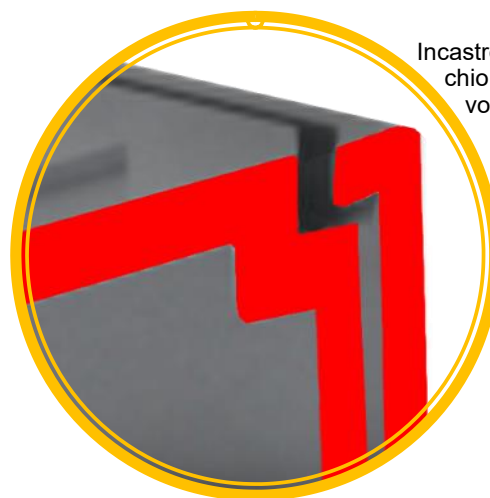



2025

Chiusini in ghisa sferoidale
Ductile cast iron manhole tops

26

Certificazioni
Certifications



LEONARDO ERMETICO con chiusura automatica

Chiusino in ghisa sferoidale GJS-500-7 – EN 1563 prodotto, secondo quanto sancito dall'ultima edizione della norma UNI EN 124, da azienda certificata ISO 9001:2015, costituito da telaio di forma quadrata sia alla base di appoggio che alla sommità corrispondente al livello del piano stradale, munito di: adeguata aletta perimetrale esterna, continua sui quattro lati, opportunamente sagomata e smussata agli angoli per ottenere una maggiore base di appoggio e consentire un migliore ancoraggio alla fondazione anche mediante fori/ asole utili al fissaggio con tirafondi, costole di rinforzo, incastro antisfilamento per l'accoppiamento univoco col coperchio, sede interna a "U" per ottenere la ermeticità agli odori mediante riempimento di sabbia e/o materiali equivalenti in accoppiamento col coperchio, vano/i esterno opportunamente dimensionato per l'inserimento di una leva per l'apertura. Coperchio di forma quadrata munito di: sistema di chiusura formato da appendice/i elastica opportunamente sagomata che si incastra con la linguetta presente sul telaio e sbloccabile con una generica leva; asole a fondo chiuso idonee ad accogliere le chiavi di sollevamento; spazio per l'inserimento di eventuali scritte e/o loghi (es. ente appaltante + etc.); particolare identificativo delle dimensioni esterne del telaio espresse in cm.; rilievo antisdrucchiolo opportunamente conformato per il completo deflusso delle acque di scorrimento; angoli smussati per il posizionamento univoco all'interno del telaio. Tutti i coperchi ed i telai devono riportare la norma di riferimento, la classe di resistenza, il marchio del produttore in codice e la data del lotto di produzione.

Ductile cast iron GJS-500-7 - EN 1563 Manhole cover produced, according to provision of the latest edition of the UNI EN 124; by ISO 9001:2015 certified company; consisting of a frame with a square shape at both, the supporting base and the top corresponding to the street level, provided with a outer winglet all along the four sides with shaped and bevelled corners to obtain a greater supporting base and allow a better anchorage to the foundation also by holes / elongated holes (for the class D400) useful for the fastening with anchor bolts, reinforcing ribs, constraining block for the unique matching with the cover, "U" shaped internal seat to achieve the air-tightness odors by filling with sand and/or equivalent materials when coupled with the cover, external seat shaped for the inserting of an opening tool. Square shape cover provided with: locking device made by elastic tongue/s that locks under the frame tongue and unlocks with a generic lever, blind slots for the inserting of the lifting keys; room for the insertion of any writings and/or logos (e.g. contracting entity + etc.); number to identify the external dimension of the frame, expressed in cm.; anti-slippery surface suitably shaped for the complete water runoff, bevelled corner for the unique matching with the frame. All covers and frames must display: the reference standard, the loading class, the mark of the manufacturer in code and the date of the batch.





LEONARDO ERMETICO con chiusura automatica



CODICE CODE	CLASSE CLASS	DIMENSIONI ESTERNE EXTERNAL DIMENSIONS mm	LUCE NETTA CLEAR OPENING mm	ALTEZZA HEIGHT mm	PESO TOTALE TOTAL WEIGHT Kg.	PEZZI PER PEDANA PIECES ON PALLET n.	NOTE NOTES	LISTINO PRICE LIST €
LEO20B/ERM	B125	200X200	140X140	25	3	300	NON VINCOLATO NOT CONSTRAINED	30,00
LEO30B/ERM	B125	300X300	200X200	30	5,3	48		45,00
LEO40B/ERM	B125	400X400	300X300	30	8,5	48		62,00
LEO50B/ERM	B125	500X500	400X400	30	13,5	20		99,00
LEO55B/ERM	B125	550X550	450X450	35	19	20		139,00
LEO60B/ERM	B125	600X600	500X500	35	20,5	20		149,00
LEO70B/ERM	B125	700X700	600X600	40	31,5	20		229,00
LEO80B/ERM	B125	800X800	700X700	45	43,5	16		324,00
LEO90B/ERM	B125	900X900	800X800	55	61	16		454,00
LEO100B/ERM	B125	1000X1000	900X900	60	87,5	12		669,00

CODICE CODE	CLASSE CLASS	DIMENSIONI ESTERNE EXTERNAL DIMENSIONS mm	LUCE NETTA CLEAR OPENING mm	ALTEZZA HEIGHT mm	PESO TOTALE TOTAL WEIGHT Kg.	PEZZI PER PEDANA PIECES ON PALLET n.	NOTE NOTES	LISTINO PRICE LIST €
LEO30C/ERM	C250	300X300	200X200	30	6,5	48		55,00
LEO40C/ERM	C250	400X400	300X300	35	11	48		80,00
LEO50C/ERM	C250	500X500	400X400	40	17,5	20		128,00
LEO55C/ERM	C250	550X550	450X450	45	23,2	20		169,00
LEO60C/ERM	C250	600X600	500X500	45	26,4	20		192,00
LEO70C/ERM	C250	700X700	600X600	50	38,8	18		282,00
LEO80C/ERM	C250	800X800	700X700	55	52,8	15		393,00
LEO90C/ERM	C250	900X900	800X800	65	73	12		544,00
LEO100C/ERM	C250	1000X1000	900X900	70	103	8		838,00

CODICE CODE	CLASSE CLASS	DIMENSIONI ESTERNE EXTERNAL DIMENSIONS mm	LUCE NETTA CLEAR OPENING mm	ALTEZZA HEIGHT mm	PESO TOTALE TOTAL WEIGHT Kg.	PEZZI PER PEDANA PIECES ON PALLET n.	NOTE NOTES	LISTINO PRICE LIST €
LEO40D/ERM	D400	400X400	270X270	75	17	24		124,00
LEO50D/ERM	D400	500X500	400X400	75	26,5	20		193,00
LEO55D/ERM	D400	550X550	450X450	75	33	20		240,00
LEO60D/ERM	D400	600X600	500X500	75	36,5	20		266,00
LEO70D/ERM	D400	700X700	600X600	75	52	10		378,00
LEO80D/ERM	D400	800X800	700X700	75	71	10		517,00
LEO90D/ERM	D400	900X900	800X800	75	93	10		692,00
LEO100D/ERM	D400	1000X1000	900X900	80	124	8		948,00
LEO110D/ERM	D400	1100X1100	1000X1000	80	145	6		1.108,00
LEO120D/ERM	KN400	1200X1200	1100X1100	80	183	5	NON VINCOLATO NOT CONSTRAINED	1.398,00



NON PREVISTO DALLA NORMA EN124

NOT INCLUDED IN EN124 STANDARD

Disponibilità immediata con le seguenti personalizzazioni:

Immediate availability with the following customization:

FOGNATURA
PUBBLICA ILLUMINAZIONE

ACQUEDOTTO
GAS



Chiusini in ghisa sferoidale
Ductile cast iron manhole tops

27



Certificazioni
Certifications

LEONARDO ERMETICO



POSA IN OPERA E MANUTENZIONE INSTALLATION AND MAINTENANCE

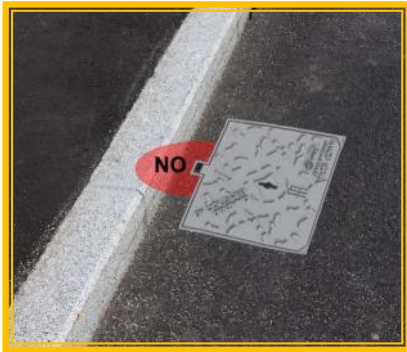

fig. 1
pic. 1

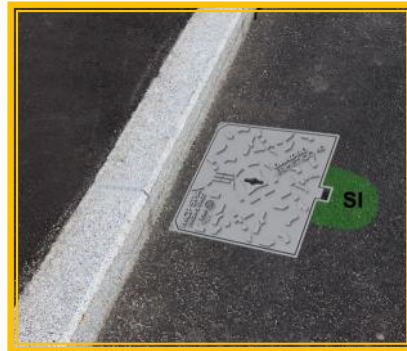

fig. 2
pic. 2

- Non posare il chiusino con l'asola di apertura rivolta verso parti ostruenti quali cordoli, marciapiedi, muri, etc. (fig. 1)
- Per l'apertura del chiusino è necessario lasciare l'area di manovra della leva di sblocco libera da ostacoli. (fig. 2)
- Per la posa in opera seguire le istruzioni indicate a pag. 10 e contenute nel documento UNI/TR 11256.
- Si raccomanda di non ostruire e di tenere pulita la parte di telaio destinata alla ricezione del meccanismo di chiusura.
- Do not install the device with the locking mechanism facing against any obstacle as kerbs, side-walks, walls etc. (pic. 1)
- To perform the opening of the device it is necessary to keep enough room for the unlocking operation. (pic. 2)
- For installation procedures refer to instruction at page 10 and those provided by UNI/TR 11256.
- It is recommended not to obstruct and to keep clean the part of the frame in correspondence of the locking mechanism.



MODALITA' DI APERTURA OPENING/CLOSING OPERATIONS

- Inserire una leva (leverino o piede di porco) nell'apposito alloggiamento indicato sul bordo del coperchio (fig. 3).
- Spingere il coperchio sul lato opposto.
- Fare leva verso il basso fino allo sblocco del sistema di chiusura (fig. 4).
- Inserire la chiave "CHIAVE/LEO" nell'asola cieca per il sollevamento del coperchio (fig. 5).
- Per la chiusura, riposizionare il coperchio nella sede e imprimere una forza necessaria sul sistema di chiusura fino al blocco dello stesso.
- Insert a lever into the provided slot on the side of the cover (pic. 3).
- Push the cover towards the opposite side.
- Push the lever down until it unlocks the locking system (pic. 4).
- Insert the lifting key "CHIAVE/LEO" in the blind slot to lift the cover up (pic. 5).
- To close, put the cover back into its seat and give the necessary strength on the locking system to lock it.

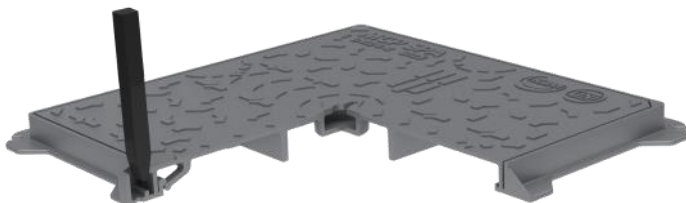

fig. 3
pic. 3

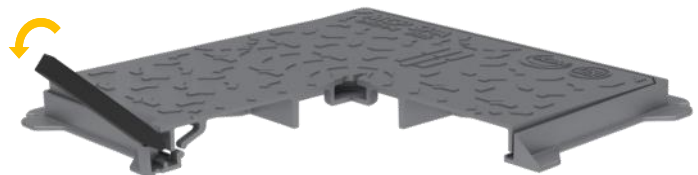

fig. 4
pic. 4



fig. 5
pic. 5



TINTORETTO

Apertura Assistita



2025

Pulsante per lo sblocco della molla a gas.
Button to unlock the gas spring.



Chiusini in ghisa sferoidale
Ductile cast iron manhole tops

29

CARATTERISTICHE:

- ⇒ Carico di rottura > 400kN
Breaking load > 400kN
- ⇒ Ideali per pozzetti di serbatoi carburanti.
Suitable for petrol tanks.
- ⇒ Apertura assistita con due molle a gas, di cui una con blocco chiusura con pulsante colorato.
Opening assisted by two gas springs, one of which has a coloured button block system.
- ⇒ Telaio con bordo perimetrale scatolare per un migliore ancoraggio alla fondazione.
Frame with a perimeter edge box-type for better anchoring to the foundation.
- ⇒ Guarnizione in elastomero incassata nel telaio che garantisce silenziosità e stabilità.
Elastomeric cushioning insert fitted into the frame that ensures quietness and stability.
- ⇒ Coperchio con profilo radiale per il completo deflusso delle acque di scorrimento.
Cover with radial profile for the complete flow of runoff water.
- ⇒ Identificazione dimensionale del prodotto.
Identification of the product size.



Certificazioni
Certifications

CODICE	CLASSE	DIMENSIONI ESTERNE	LUCE NETTA	ALTEZZA	PESO TOTALE	PEZZI PER PEDANA	NOTE	LISTINO
CODE	CLASS	EXTERNAL DIMENSIONS	CLEAR OPENING	HEIGHT	TOTAL WEIGHT	PIECES ON PALLET	NOTES	PRICE LIST
		mm	mm	mm	Kg.	n.		€
TIN87D	D400	870X935	760X760	102	126	6		1.863,00



2025

Chiusini in ghisa sferoidale
Ductile cast iron manhole tops

TINTORETTO



CARATTERISTICHE:

- ⇒ Carico di rottura > 250kN per la classe **C250**
> 400kN per la classe **D400**
Breaking load > 250kN for class **C250**
> 400kN for class **D400**
- ⇒ Telaio con aletta perimetrale esterna, continua sui quattro lati, con asole e/o fori per una maggiore base di appoggio e un migliore ancoraggio alla fondazione.
Frame with a continuous outer winglet along the four sides with elongated holes and or holes for a greater supporting base and a better anchorage to the foundation.
- ⇒ Sistema di chiusura con chiave.
Key locking system.
- ⇒ Identificazione dimensionale del prodotto.
Identification of the product size.



30

open fiber



CODICE	CLASSE	DIMENSIONI ESTERNE	LUCE NETTA	ALTEZZA	PESO TOTALE	PEZZI PER PEDANA	NOTE	LISTINO
CODE	CLASS	EXTERNAL DIMENSIONS	CLEAR OPENING	HEIGHT	TOTAL WEIGHT	PIECES ON PALLET	NOTES	PRICE LIST
		mm	mm	mm	Kg.	n.		€
TIN48C	C250	480X480	376X376	55	24	28		213,00
TIN55D	D400	550X550	450X450	75	41	24		405,00
TIN55D/100	i D400	550X550	450X450	100	38	13		277,00
TIN2651D	i D400	260X510	135X385	75	17	28		124,00

- OMOLOGATI **OPEN FIBER** / INFRATEL ITALIA (BUL)
 - APPROVED **OPEN FIBER** / INFRATEL ITALIA (BUL)

Certificazioni
Certifications





TINTORETTO

Grandi Luci



2025



CARATTERISTICHE:

⇒ Carico di rottura > 400kN
Breaking load > 400kN

⇒ Telaio con aletta perimetrale esterna, continua sui quattro lati, con asole e/o fori per una maggiore base di appoggio e un migliore ancoraggio alla fondazione.

Frame with a continuous outer winglet along the four sides with elongated holes and or holes for a greater supporting base and a better anchorage to the foundation.

⇒ Coperchi, bullonati al telaio.
Covers, bolted to the frame.

⇒ Identificazione dimensionale del prodotto.
Identification of the product size.

**NEW
PRODUCT**

CODICE CODE	CLASSE CLASS	DIMENSIONI ESTERNE EXTERNAL DIMENSIONS mm	LUCE NETTA CLEAR OPENING mm	ALTEZZA HEIGHT mm	PESO TOTALE TOTAL WEIGHT Kg.	PEZZI PER PEDANA PIECES ON PALLET n.	NOTE NOTES	LISTINO PRICE LIST €
TIN92117D	D400	920X1170	750X1000	100	160	5	2 COPERCHI 2 COVERS	1.971,00
TIN76140D	D400	765X1400	600X1200	100	140	5	2 COPERCHI 2 COVERS	1.725,00
TIN94139D	D400	946X1396	750X1200	100	162	5	2 COPERCHI 2 COVERS	1.996,00
TIN93170D	D400	930X1700	750X1500	100	186	3	2 COPERCHI 2 COVERS	2.292,00

Chiusini in ghisa sferoidale
Ductile cast iron manhole tops

31

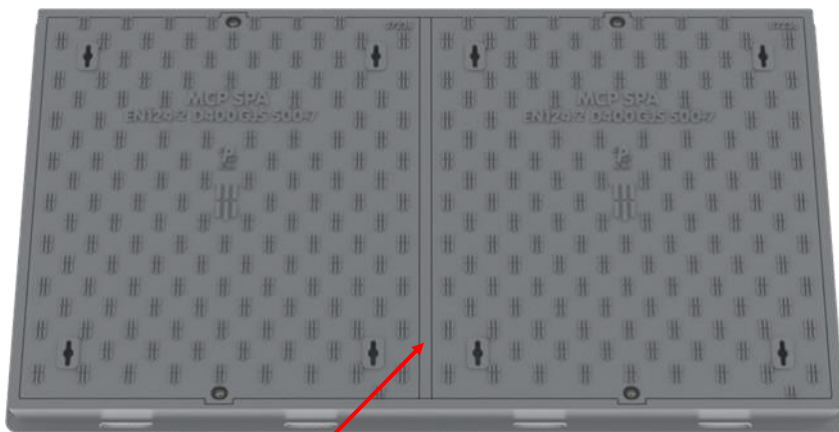

BARRA REMOVIBILE
REMOVABLE BAR

CARATTERISTICHE:

⇒ Carico di rottura > 400kN
Breaking load > 400kN

⇒ Telaio con aletta perimetrale esterna, continua sui quattro lati, con asole e/o fori per una maggiore base di appoggio e un migliore ancoraggio alla fondazione.

Frame with a continuous outer winglet along the four sides with elongated holes and or holes for a greater supporting base and a better anchorage to the foundation.

⇒ Barra/e centrale/i removibile/i per ottenere la massima luce netta.
Central removable bar/s for the maximum clear opening.

⇒ Doppia guarnizione in elastomero incassata nel telaio che garantisce silenziosità e stabilità.
Double elastomeric cushioning insert fitted into the frame that ensures quietness and stability.

⇒ Coperchi, bullonati al telaio, con doppia battuta per la maggiore ermeticità.
Covers, bolted to the frame, with double seating for a better air tightness.

⇒ Identificazione dimensionale del prodotto.
Identification of the product size.

CODICE CODE	CLASSE CLASS	DIMENSIONI ESTERNE EXTERNAL DIMENSIONS mm	LUCE NETTA CLEAR OPENING mm	ALTEZZA HEIGHT mm	PESO TOTALE TOTAL WEIGHT Kg.	PEZZI PER PEDANA PIECES ON PALLET n.	NOTE NOTES	LISTINO PRICE LIST €
TIN87160D/A	D400	870X1600	700X1430	100	316	6	2 COPERCHI 2 COVERS	3.893,00
TIN87236D/A	D400	870X2365	700X2200	100	464	3	3 COPERCHI 3 COVERS	5.716,00



Certificazioni
Certifications



2025

Chiusini in ghisa sferoidale
Ductile cast iron manhole tops

32

Certificazioni
Certifications

PAVE'

NEW
PRODUCT

CARATTERISTICHE:

- ⇒ Carico di rottura > 125kN per la classe **B125**
Breaking load > 125kN for class **B125**
> 250kN per la classe **C250**
> 250kN for class **C250**
- ⇒ Ideale per masselli autobloccanti.
Ideal for block paving.
- ⇒ Telaio con battuta interna "U" per l'ermeticità agli odori.
Frame with "U" shaped internal seating for airtight.
- ⇒ Telaio senza aletta perimetrale esterna.
Frame without outer winglet.
- ⇒ Identificazione dimensionale del prodotto.
Identification of the product size.

CODICE	CLASSE	DIMENSIONI ESTERNE	LUCE NETTA	ALTEZZA	PESO TOTALE	PEZZI PER PEDANA	NOTE	LISTINO
CODE	CLASS	EXTERNAL DIMENSIONS	CLEAR OPENING	HEIGHT	TOTAL WEIGHT	PIECES ON PALLET	NOTES	PRICE LIST
		mm	mm	mm	Kg.	n.		€
PAV38B/IC	B125	380X380	310X310	30	11	60		98,00
PAV48B/IC	B125	480X480	410X410	40	18	20		160,00
PAV58B/IC	B125	580X580	504X504	40	25	20		222,00
PAV68B/IC	B125	680X680	604X604	40	34	20		302,00
PAV46C/IC	C250	460X460	404X404	50	23	20		204,00
PAV51C/IC	C250	512X512	450X450	50	28,5	20		253,00
PAV58C/IC	C250	580X580	504X504	50	33	20		293,00
PAV68C/IC	C250	680X680	604X604	50	44	10		391,00
CSQB38/AU	B125	380X380	310X310	60	17	60		151,00
CSQB48/AU	B125	480X480	410X410	60	27	52		240,00
CSQC46/AU	C250	460X460	400X400	80	35	28		311,00
CSQC51/AU	C250	512X512	450X450	80	41	28		364,00



CARAVAGGIO



CARATTERISTICHE:

- ⇒ Carico di rottura > 125kN
Breaking load > 125kN
- ⇒ Telaio quadro con coperchio circolare.
Square frame with round cover.
- ⇒ Telaio senza aletta perimetrale esterna.
Frame without outer winglet.



CODICE	CLASSE	DIMENSIONI ESTERNE	LUCE NETTA	ALTEZZA	PESO TOTALE	PEZZI PER PEDANA	NOTE	LISTINO
CODE	CLASS	EXTERNAL DIMENSIONS	CLEAR OPENING	HEIGHT	TOTAL WEIGHT	PIECES ON PALLET	NOTES	PRICE LIST
		mm	mm	mm	Kg.	n.		€
CAR40B	B125	400X400	Ø 250	18	9,7	52		53,00



CARATTERISTICHE:

- ⇒ Carico di rottura > 250kN
Breaking load > 250kN
- ⇒ Chiusino con doppio coperchio ispezionabile ideale per la lettura dei contatori.
Manhole with double cover with inspection pit ideal for water meters readings.
- ⇒ Telaio con aletta perimetrale esterna, continua sui quattro lati, per una maggiore base di appoggio e un migliore ancoraggio alla fondazione.
Frame with a continuous outer winglet along the four sides for a greater supporting base and a better anchorage to the foundation.
- ⇒ Identificazione dimensionale del prodotto.
Identification of the product size.

ACQUEDOTTO

CODICE CODE	CLASSE CLASS	DIMENSIONI ESTERNE EXTERNAL DIMENSIONS mm	LUCE NETTA CLEAR OPENING mm	ALTEZZA HEIGHT mm	PESO TOTALE TOTAL WEIGHT Kg.	PEZZI PER PEDANA PIECES ON PALLET n.	LUCE ISPEZIONE CLEAR OPENING INSPECTION TRAPDOOR mm	LISTINO PRICE LIST €
SIR60C	C250	600X600	500X500	55	45	10	202X202	400,00
SIR69C	C250	690X690	560X560	80	55	10	302X302	488,00

SIRONI

Con Botola per Ispezioni



2025

Chiusini in ghisa sferoidale
Ductile cast iron manhole tops



CARATTERISTICHE:

- ⇒ Carico di rottura > 125kN per la classe **B125**
> 250kN per la classe **C250**
> 400kN per la classe **D400**
Breaking load > 125kN for class **B125**
> 250kN for class **C250**
> 400kN for class **D400**
- ⇒ Telaio con battuta interna "U" per l'ermeticità agli odori.
Frame with "U" shaped internal seating for airtight.
- ⇒ Aletta perimetrale esterna, continua sui quattro lati del telaio, per una maggiore base di appoggio e un migliore ancoraggio alla fondazione.
Continuous outer winglet along the four sides for a greater supporting base and a better anchorage to the foundation.
- ⇒ Identificazione dimensionale del prodotto.
Identification of the product size.

MASACCIO

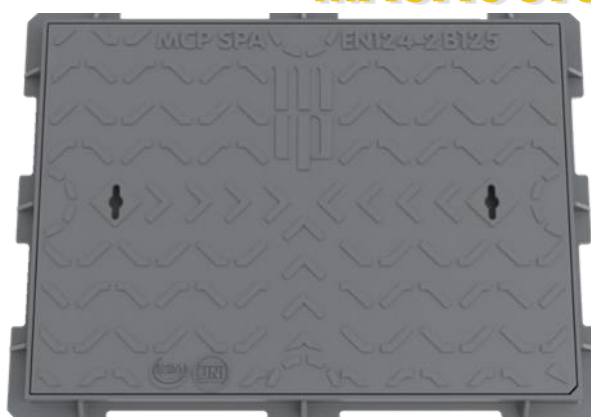

MAS6080B



MAS5070C

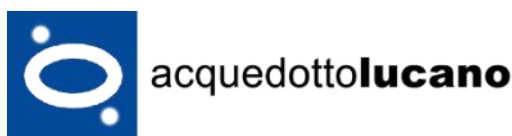

CODICE CODE	CLASSE CLASS	DIMENSIONI ESTERNE EXTERNAL DIMENSIONS mm	LUCE NETTA CLEAR OPENING mm	ALTEZZA HEIGHT mm	PESO TOTALE TOTAL WEIGHT Kg.	PEZZI PER PEDANA PIECES ON PALLET n.	NOTE NOTES	LISTINO PRICE LIST €
MAS6080B	B125	600X800	500X700	40	33	10		240,00
MAS5070C	C250	500X700	400X600	45	31	10		253,00
MAS6080C	C250	600X800	500X700	50	45	10		328,00
MAS6080D	D400	600X800	500X700	75	58	10		422,00

33



Certificazioni
Certifications



2025

Chiusini in ghisa sferoidale
Ductile cast iron manhole tops

GIAMBELLINO



CARATTERISTICHE:

- ⇒ Carico di rottura > 250kN per la classe **C250**
> 400kN per la classe **D400**
Breaking load > 250kN for class **C250**
> 400kN for class **D400**
- ⇒ Ideale per pavimentazioni lastricate e porfidi.
Ideal for porphyry paving.
- ⇒ Telaio senza aletta perimetrale esterna.
Frame without outer winglet.



34



RIEMPIMENTO DEI COPERCHI CON IL CALCESTRUZZO FILLING OF THE COVERS WITH CONCRETE

Il riempimento in calcestruzzo dei coperchi di chiusini Giambellino impone soprattutto nei luoghi di posa in cui vi sono elevati sbalzi di temperatura o che presuppongono un impiego particolarmente gravoso per i chiusini l'esecuzione secondo determinate regole. La superficie interna dei coperchi dovrà essere scevra da ogni residuo che possa compromettere la presa del calcestruzzo (olio, grasso, sabbia, etc.). Il calcestruzzo dovrà essere gettato ad una temperatura non inferiore a 10° C. Il riempimento va eseguito in giusta misura e livellato opportunamente. Mantenere la stessa scabrosità della carreggiata. Dopo il riempimento, per le prime 24 ore di maturazione è opportuno coprire con un telo il getto evitando l'essiccamento rapido. Se la temperatura esterna è inferiore a 10° C la protezione dovrà mantenersi per le prime 48 ore. Per la maturazione del calcestruzzo seguire i tempi e le istruzioni d'uso indicate dal fabbricante delle malte.

The filling of the manhole tops model Giambellino must be performed according to certain statements, mainly on the laying sites submitted to sudden temperature changes, or requiring a very stressed utilization of the device. The internal surface of the covers must be free of any residual that may compromise the setting of the mortar (oil, grease, ands ecc), The mortar must be filled at a temperature not lower than 10° C, in the right measure and duly levelled. The same roughness of the pavement must be preserved. The covering of the device with a sheet , for the first 24 hours of aging, is appropriated to avoid a fast hardening. Should the temperature be lower than 10° C, the protection must be kept for the first 48 hours. The aging of the mortar must be performed according to the times and instructions given by the mortar producer.



Certificazioni
Certifications

CODICE	CLASSE	DIMENSIONI ESTERNE	LUCE NETTA	ALTEZZA	PESO TOTALE	PEZZI PER PEDANA	NOTE	LISTINO
CODE	CLASS	EXTERNAL DIMENSIONS	CLEAR OPENING	HEIGHT	TOTAL WEIGHT	PIECES ON PALLET	NOTES	PRICE LIST
		mm	mm	mm	Kg.	n.		€
GIA30C	C250	300X300	205X205	90	18	40	PROFONDITA' INTERNA 75 mm 75 mm INTERNAL DEPTH	144,00
GIA40C	C250	400X400	305X305	90	24	40	PROFONDITA' INTERNA 75 mm 75 mm INTERNAL DEPTH	192,00
GIA50C	C250	500X500	405X405	90	37	24	PROFONDITA' INTERNA 75 mm 75 mm INTERNAL DEPTH	296,00
GIA60C	C250	600X600	505X505	90	49	16	PROFONDITA' INTERNA 75 mm 75 mm INTERNAL DEPTH	392,00
GIA70C	C250	700X700	605X605	90	65	10	PROFONDITA' INTERNA 75 mm 75 mm INTERNAL DEPTH	519,00
GIA50D	D400	500X500	405X405	100	45	24	PROFONDITA' INTERNA 84 mm 84 mm INTERNAL DEPTH	360,00
GIA60D	D400	600X600	505X505	100	60	16	PROFONDITA' INTERNA 84 mm 84 mm INTERNAL DEPTH	479,00
GIA70D	D400	700X700	605X605	100	81	10	PROFONDITA' INTERNA 84 mm 84 mm INTERNAL DEPTH	647,00



GIAMBELLINO



2025

CARATTERISTICHE:

- ⇒ Carico di rottura > 400kN
Breaking load > 400kN
- ⇒ Ideale per pavimentazioni lastricate e porfidi.
Ideal for porphyry paving.
- ⇒ Telaio con aletta perimetrale esterna.
Frame with outer winglet.
- ⇒ I modelli GIA7375D e GIA76132D sono adeguati alla S.T. TELECOM ITALIA n.1479/2015 e sono personalizzabili con i loghi seguenti:
The models GIA7375D and GIA76132D comply with the technical specification TELECOM ITALIA n.1479/2015 and can be customized with the following logos:



GIA7675D

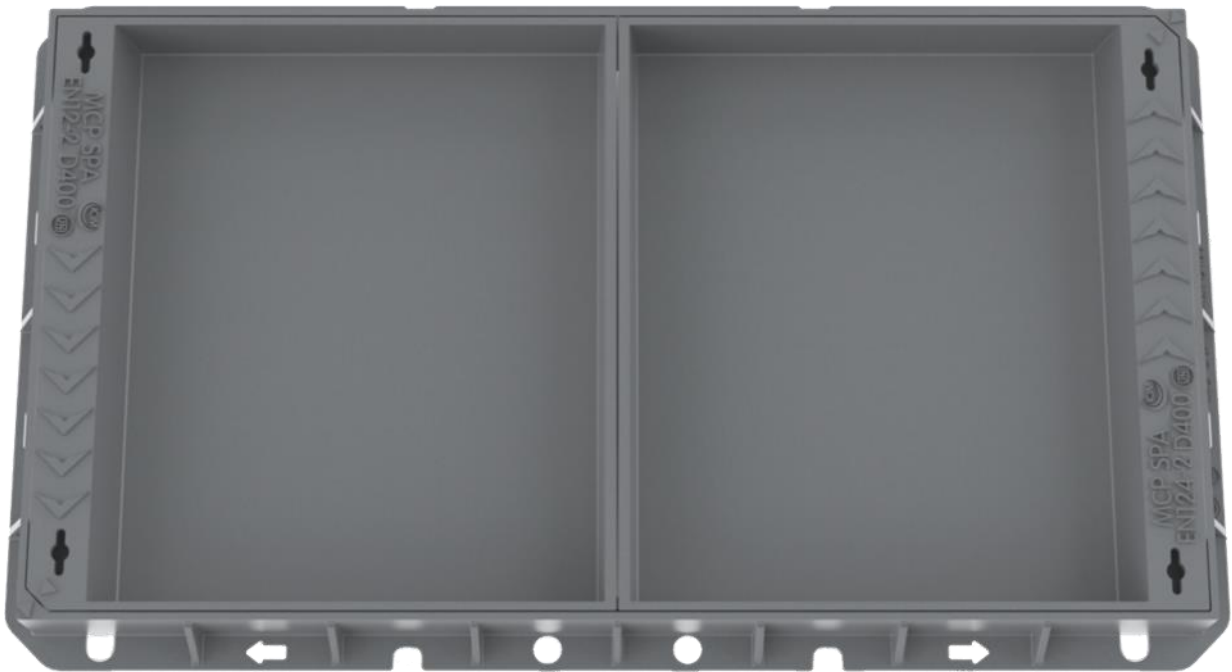

GIA76132D

Chiusini in ghisa sferoidale
Ductile cast iron manhole tops

35



CODICE	CLASSE	DIMENSIONI ESTERNE	LUCE NETTA	ALTEZZA	PESO TOTALE	PEZZI PER PEDANA	NOTE	LISTINO
CODE	CLASS	EXTERNAL DIMENSIONS	CLEAR OPENING	HEIGHT	TOTAL WEIGHT	PIECES ON PALLET	NOTES	PRICE LIST
		mm	mm	mm	Kg.	n.		€
GIA7375D	D400	730X750	600X600	100	84	5	PROFONDITA' INTERNA 80 mm 80 mm INTERNAL DEPTH	828,00
GIA76132D	D400	760X1320	600X1200	100	155	5	2 COPERCHI - PROF. INT. 80 mm 2 COVERS - 80 mm INT. DEPTH	1.528,00

Certificazioni
Certifications





2025

Chiusini in ghisa sferoidale
Ductile cast iron manhole tops

36



Certificazioni
Certifications

TELEFONIA ICON



TEL7477D/IC

- ⇒ Blocco del coperchio a 90°. Safety cover stop at 90°.
- ⇒ 2 Coperchi triangolari con cerniere e appoggio tripode di cui il primo (maestro), provvisto di serratura, che chiude l'altro (servente) dotato di placca di bloccaggio. 2 Triangular covers with hinges and 3 supporting points, of which the first cover (master) provided with locking system, locks the other (servant) provided with locking plate.

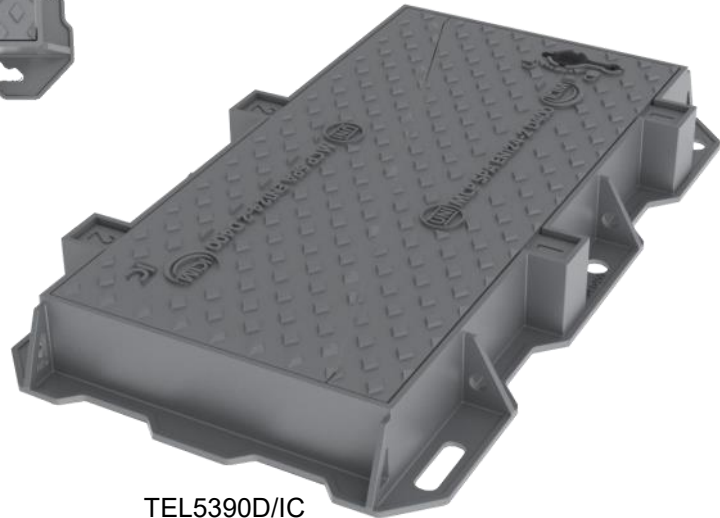

TEL5390D/IC

CARATTERISTICHE:

- ⇒ Carico di rottura > 400kN
Breaking load > 400kN
- ⇒ Telaio con aletta perimetrale esterna, continua sui quattro lati, con asole e/o fori per una maggiore base di appoggio e un migliore ancoraggio alla fondazione.
Frame with a continuous outer winglet along the four sides with elongated holes and or holes for a greater supporting base and a better anchorage to the foundation.
- ⇒ Sistema di chiusura con chiave.
Key locking system.

CODICE	CLASSE	DIMENSIONI ESTERNE	LUCE NETTA	ALTEZZA	PESO TOTALE	PEZZI PER PEDANA	NOTE	LISTINO
CODE	CLASS	EXTERNAL DIMENSIONS	CLEAR OPENING	HEIGHT	TOTAL WEIGHT	PIECES ON PALLET	NOTES	PRICE LIST
		mm	mm	mm	Kg.	n.		€
TEL5390D/IC	i D400	530X900	400X760	100	69	10		546,00
TEL7477D/IC	ii D400	742X777	600X600	100	73	10		582,00
TEL9293D/IC	D400	920X930	750X750	100	116	8		1.153,00
TEL105108D/IC	D400	1050X1080	900X900	110	171	6		1.641,00



i - Adeguato alla S.T. TELECOM ITALIA n° 915/2015

i - Complying with the Tech. Spec. TELECOM ITALIA n° 915/2015

ii - Adeguato alla S.T. TELECOM ITALIA n° 1480/2015

ii - Complying with the Tech. Spec. TELECOM ITALIA n° 1480/2015

NEW PRODUCT

CODICE	CLASSE	DIMENSIONI ESTERNE	LUCE NETTA	ALTEZZA	PESO TOTALE	PEZZI PER PEDANA	NOTE	LISTINO
CODE	CLASS	EXTERNAL DIMENSIONS	CLEAR OPENING	HEIGHT	TOTAL WEIGHT	PIECES ON PALLET	NOTES	PRICE LIST
		mm	mm	mm	Kg.	n.		€
TEL6274D	D400	620X740	450X600	100	65	10		577,00
TEL80110D	D400	800X1100	600X900	100	122	8		1.083,00
TEL8794D/IC	D400	872X945	700X800	100	103	8		1.153,00

open fiber

#BUL
RETE PUBBLICA
BANDA ULTRA LARGA

TIM

vodafone

WINDTRE

enel

Terna
TERNA GROUP

HERA

acea



TELEFONIA ICON



2025

CARATTERISTICHE:

- ⇒ Carico di rottura > 400kN
Breaking load > 400kN
- ⇒ Telaio con aletta perimetrale esterna, continua sui quattro lati, con asole e/o fori per una maggiore base di appoggio e un migliore ancoraggio alla fondazione.
Frame with a continuous outer winglet along the four sides with elongated holes and or holes for a greater supporting base and a better anchorage to the foundation.
- ⇒ Sistema di chiusura con chiave.
Key locking system.
- ⇒ Blocco del coperchio a 90°.
Safety cover stop at 90°.
- ⇒ 4 Coperchi triangolari con cerniere e appoggio tripode di cui il primo (maestro), provvisto di serratura, che chiude sequenzialmente gli altri (serventi) dotati di placca di bloccaggio.
4 Triangular covers, with hinges and 3 supporting points one of which (master) has a locking system that locks the others (servants) provided with locking plate.

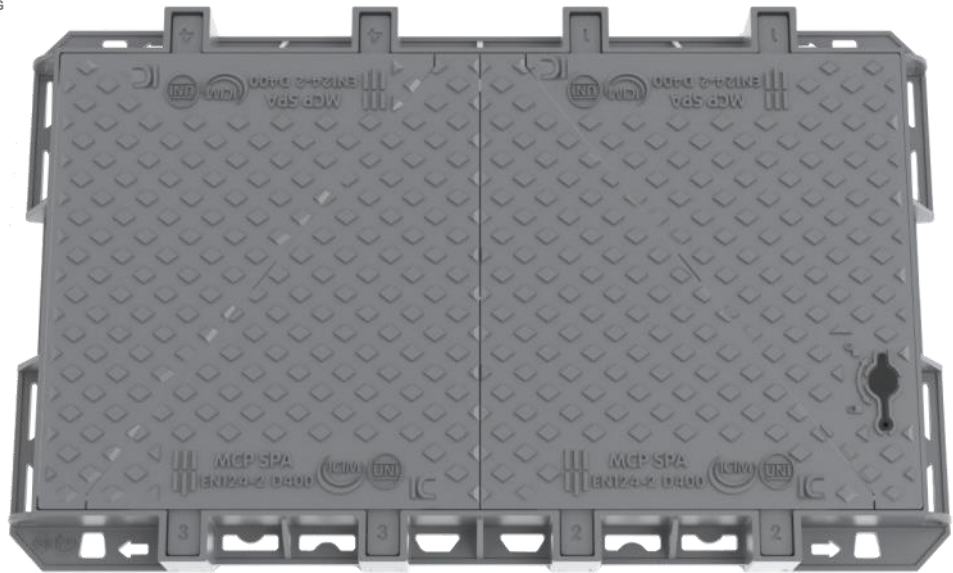

TEL78135D/IC

Chiusini in ghisa sferoidale
Ductile cast iron manhole tops

CODICE CODE	CLASSE CLASS	DIMENSIONI ESTERNE EXTERNAL DIMENSIONS mm	LUCE NETTA CLEAR OPENING mm	ALTEZZA HEIGHT mm	PESO TOTALE TOTAL WEIGHT Kg.	PEZZI PER PEDANA PIECES ON PALLET n.	NOTE NOTES	LISTINO PRICE LIST €
TEL78135D/IC	D400	780X1350	600X1200	100	146	6		1.142,00
TEL88116D/IC	D400	882X1164	700X1060	100	149	6		1.185,00
TEL93167D/IC	D400	930X1670	750X1500	120	270	5		2.599,00
TEL118135D/IC	D400	1180X1350	1000X1200	120	327	6		3.078,00
TEL118165D/IC	D400	1180X1650	1000X1500	120	385	4		3.637,00

37

i - Adeguato alla S.T. TELECOM ITALIA n° 1480/2015
i - Complying with the Tech. Spec. TELECOM ITALIA n° 1480/2015



**NEW
PRODUCT**

CODICE CODE	CLASSE CLASS	DIMENSIONI ESTERNE EXTERNAL DIMENSIONS mm	LUCE NETTA CLEAR OPENING mm	ALTEZZA HEIGHT mm	PESO TOTALE TOTAL WEIGHT Kg.	PEZZI PER PEDANA PIECES ON PALLET n.	NOTE NOTES	LISTINO PRICE LIST €
TEL95242D	D400	950X2420	750x2250	100	320	5		2.839,00
TEL98150D	D400	980X1500	800x1300	100	236	5		2.094,00

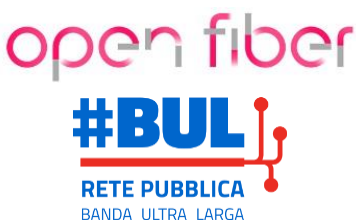

Certificazioni
Certifications



2025

Chiusini in ghisa sferoidale
Ductile cast iron manhole tops

38



Certificazioni
Certifications

TELEFONIA



CARATTERISTICHE:

- ⇒ Carico di rottura > 400kN
Breaking load > 400kN
- ⇒ Telaio con aletta perimetrale esterna, continua sui quattro lati, con asole e/o fori per una maggiore base di appoggio e un migliore ancoraggio alla fondazione.
Frame with a continuous outer winglet along the four sides with elongated holes and or holes for a greater supporting base and a better anchorage to the foundation.
- ⇒ Sistema di chiusura con chiave.
Key locking system.
- ⇒ Blocco del coperchio a 90°.
Safety cover stop at 90°.



TEL7477D

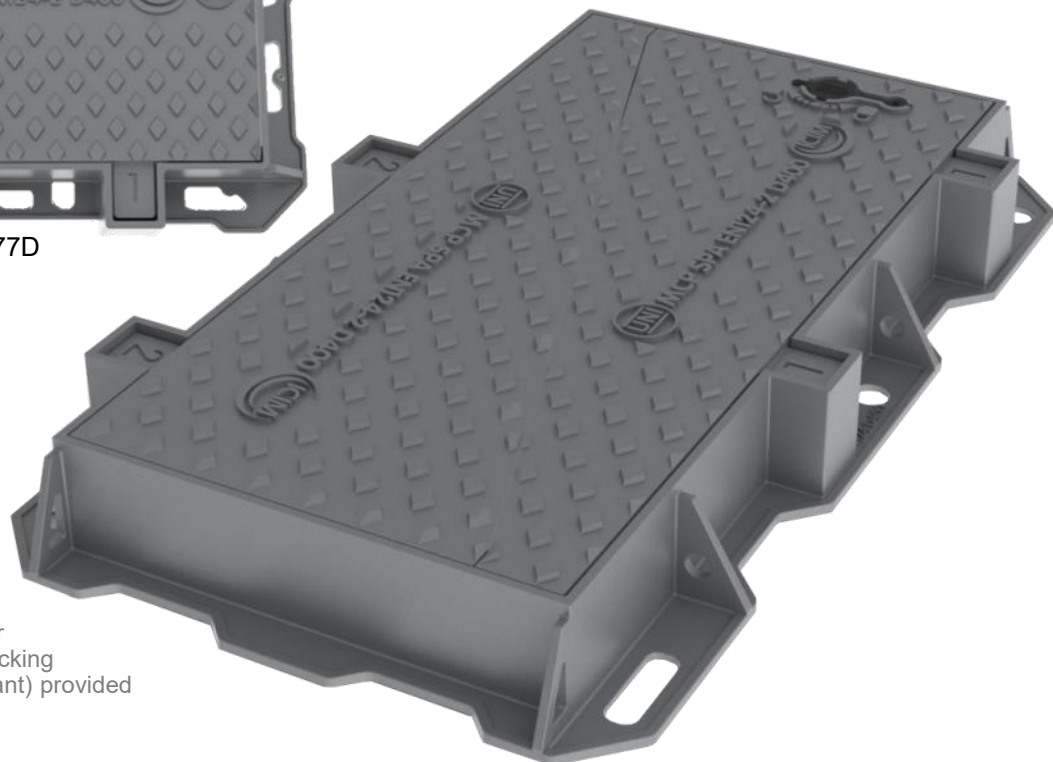

TEL5390D

- ⇒ 2 Coperchi triangolari con cerniere e appoggio tripode di cui il primo (maestro), provvisto di serratura, che chiude l'altro (servente) dotato di placca di bloccaggio.
2 Triangular covers with hinges and 3 supporting points, of which the first cover (master) provided with locking system, locks the other (servant) provided with locking plate.

CODICE	CLASSE	DIMENSIONI ESTERNE	LUCE NETTA	ALTEZZA	PESO TOTALE	PEZZI PER PEDANA	NOTE	LISTINO
CODE	CLASS	EXTERNAL DIMENSIONS	CLEAR OPENING	HEIGHT	TOTAL WEIGHT	PIECES ON PALLET	NOTES	PRICE LIST
		mm	mm	mm	Kg.	n.		€
TEL5390D	i D400	530X900	400X760	100	75	10		546,00
TEL7477D	ii D400	742X777	600X600	100	80	10		582,00
TEL8794D	i D400	872X945	700X800	100	108	8		785,00
TEL9293D	D400	920X930	750X750	100	130	8		1.153,00
TEL105108D	D400	1050X1080	900X900	110	185	6		1.641,00

i - OMOLOGATI **OPEN FIBER**
OMOLOGATI **INFRATEL ITALIA (BUL)**
Adeguato alla S.T. TELECOM ITALIA n° 915/2015

ii - Adeguato alla S.T. TELECOM ITALIA n° 1480/2015

i - APPROVED **OPEN FIBER**
APPROVED **INFRATEL ITALIA (BUL)**
Complying with the Tech. Spec. TELECOM ITALIA n° 915/2015

ii - Complying with the Tech. Spec. TELECOM ITALIA n° 1480/2015

open fiber

#BUL
RETE PUBBLICA
BANDA ULTRA LARGA

TIM

vodafone

WINDTRE

enel

Terna

HERA

acea



TELEFONIA



2025

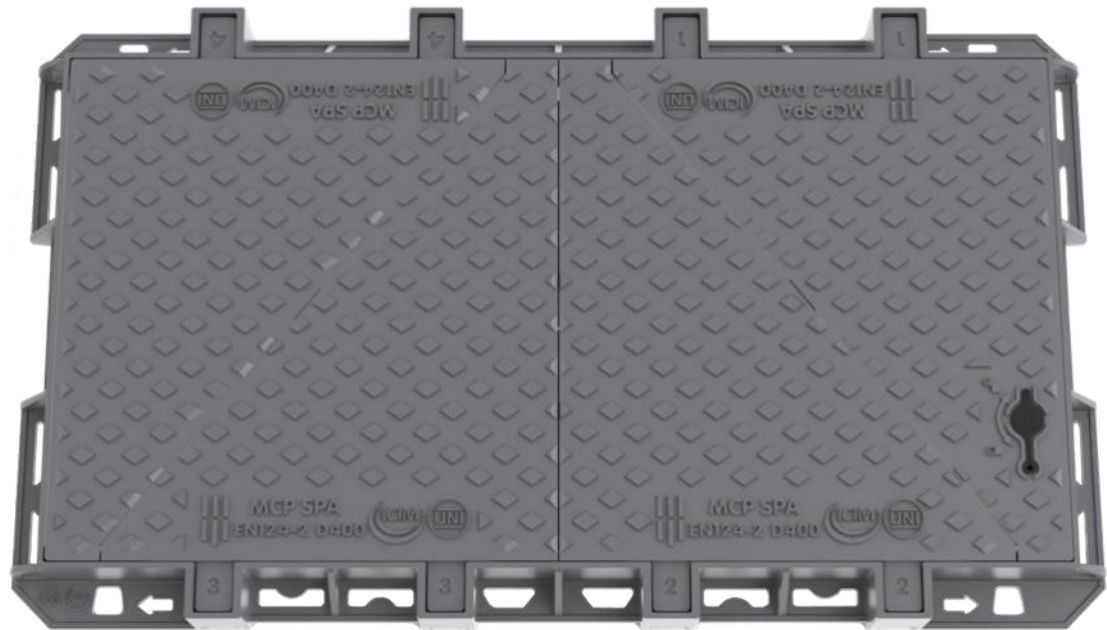

CARATTERISTICHE:

TEL78135D

- ⇒ Carico di rottura > 400kN per la classe **D400**
> 900kN per la classe **F900**
Breaking load > 400kN for class **D400**
> 900kN for class **F900**
- ⇒ Telaio con aletta perimetrale esterna, continua sui quattro lati, con asole e/o fori per una maggiore base di appoggio e un migliore ancoraggio alla fondazione.
Frame with a continuous outer winglet along the four sides with elongated holes and or holes for a greater supporting base and a better anchorage to the foundation.
- ⇒ Sistema di chiusura con chiave.
Key locking system.
- ⇒ Blocco del coperchio a 90°.
Safety cover stop at 90°.
- ⇒ 4 Coperchi triangolari con cerniere e appoggio tripode di cui il primo (maestro), provvisto di serratura, che chiude sequenzialmente gli altri (serventi) dotati di placca di bloccaggio.
4 Triangular covers, with hinges and 3 supporting points one of which (master) has a locking system that locks the others (servants) provided with locking plate.

CODICE	CLASSE	DIMENSIONI ESTERNE	LUCE NETTA	ALTEZZA	PESO TOTALE	PEZZI PER PEDANA	NOTE	LISTINO
CODE	CLASS	EXTERNAL DIMENSIONS	CLEAR OPENING	HEIGHT	TOTAL WEIGHT	PIECES ON PALLET	NOTES	PRICE LIST
		mm	mm	mm	Kg.	n.		€
TEL78135D	ii D400	780X1350	600X1200	100	157	6		1.142,00
TEL88116D	i D400	882X1164	700X1060	100	163	6		1.185,00
TEL93167D	D400	930X1670	750X1500	120	293	5		2.599,00
TEL118135D	D400	1180X1350	1000X1200	120	347	6		3.078,00
TEL118165D	D400	1180X1650	1000X1500	120	410	4		3.637,00
TEL95240F	F900	950X2400	750X2225	150	602	3		6.556,00



i - OMOLOGATI **OPEN FIBER**
OMOLOGATI **INFRATEL ITALIA (BUL)**
Adeguato alla S.T. TELECOM ITALIA n° 1480/2015

ii - Adeguato alla S.T. TELECOM ITALIA n° 1480/2015

i - APPROVED **OPEN FIBER**
APPROVED **INFRATEL ITALIA (BUL)**
Complying with the Tech. Spec. TELECOM ITALIA n° 1480/2015

ii - Complying with the Tech. Spec. TELECOM ITALIA n° 1480/2015

open fiber

#BUL
RETE PUBBLICA
BANDA ULTRA LARGA

TIM

vodafone

WINDTRE

enel

Terna
Terna GROUP

HERA

aceq

Chiusini in ghisa sferoidale
Ductile cast iron manhole tops

39



Certificazioni
Certifications



2025

Chiusini in ghisa sferoidale
Ductile cast iron manhole tops

40



Certificazioni
Certifications

RAFFAELLO COLOSSUS



CHIUSURA
AUTOMATICA
AUTO
LOCKING



90°
BLOCK
CERNIERA
HINGE



110°
MAX
CERNIERA
HINGE



GUARNIZIONE
CUSHIONING
INSERT



CLASSE
D 400

GUARNIZIONE
TRAPEZOIDALE

TRAPEZOIDAL
CUSHIONING
INSERT

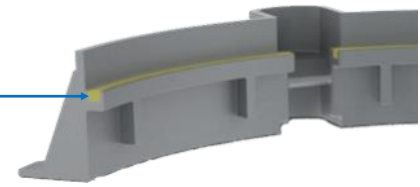

Chiusino in ghisa sferoidale GJS-500-7 - EN 1563 pro-dotto, secondo quanto sancito dall'ultima edizione in vigore delle norme UNI EN 124, da azienda certificata ISO 9001:2015, costituito da telaio, di forma quadrata/circolare/ottagonale alla base di appoggio e circolare alla sommità corrispondente al livello del piano stradale, munito di: adeguata aletta perimetrale esterna continua, di larghezza non inferiore a mm. 20 per ottenere una maggiore base di appoggio e consentire un migliore ancoraggio alla fondazione anche tramite apposite asole e/o fori creati sul perimetro; battuta interna sagomata a "U"; guarnizione antirumore ed antibasculamento opportunamente sagomata per contrastare frontalmente il bordo del coperchio ed assorbire anche le vibrazioni; vano esterno a fondo chiuso, opportunamente dimensionato per l'inserimento di una leva per l'apertura, dotato di linguetta idonea ad accogliere l'appendice elastica del coperchio per il blocco del sistema di chiusura; vano cerniera a fondo chiuso con sistema di bloccaggio del coperchio in posizione di apertura. Coperchio di forma circolare, autocentrante nel telaio, munito di: sistema di chiusura formato da una appendice elastica opportunamente sagomata che si incastra sulla linguetta presente sul telaio e sbloccabile con qualsiasi leva; asola cieca idonea ad accogliere la leva per il sollevamento; appendice idonea a garantire l'articolazione del coperchio al telaio nel vano cerniera senza impedire la estraibilità del coperchio stesso; spazio circonferenziale e centrale per l'inserimento di eventuali scritte (es. ente appaltante + etc.); rilievi antisdrucchiolo; particolare identificativo della forma esterna del telaio e delle dimensioni espresse in cm. Tutti i coperchi ed i telai devono riportare la norma di riferimento, la classe di resistenza, il marchio del produttore in codice e la data del lotto di produzione.

Ductile iron GJS-500-7 - EN 1563 manhole cover, produced according to provisions of the latest edition of the UNI EN 124, by ISO 9001:2015 certified company, consists of a square/octagonal/circular frame as supporting base and circular at the top, corresponding to the street level, provided with: a continuous perimetral outer winglet, of a width not less than mm. 20, to obtain a greater supporting base and allow a better anchorage to the foundation also by elongated holes and/or holes created along the perimeter; "U" shaped internal seat; elastomeric cushioning insert, anti-noise and anti-rocking, suitably shaped to frontally withstand the edge of the cover and absorb vibrations;

external compartment with closed bottom, suitably dimensioned for the insertion an opening lever, provided with a jut for accommodating the elastic appendix of the cover and block the locking system; hinge housing with closed bottom and cover locking system in open position. Cover of circular shape, self-centering in the frame, provided with: locking system formed by a suitably shaped elastic appendix which fits on tab on the frame and unlockable with any lever; blind slot, for the inserting of the lifting keys; an appendix suitable to ensure the positioning of the cover to the frame in the hinge compartment without preventing the extracta-

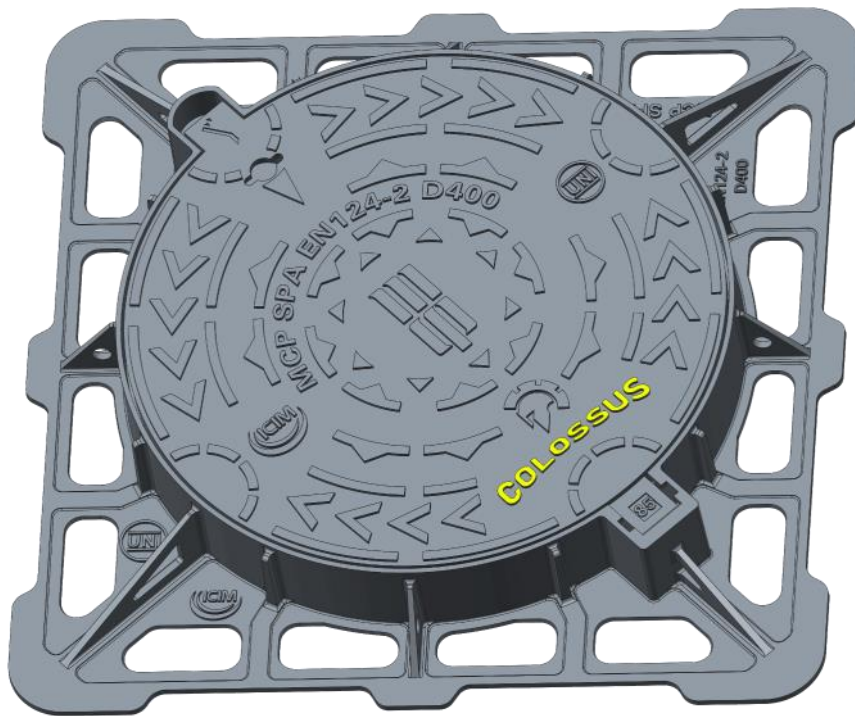

bility of the cover; central and circumferential space for the insertion of any inscription (e.g. contractor entity + etc.); anti-slippery reliefs; identification of the outer shape of the frame and of the product size, expressed in cms. All covers and frames must display: the reference standard, the loading class, the mark of the manufacturer in code and the date of the batch.

**NEW
PRODUCT**

**CONSIGLIATI PER CARREGGIATE CON TRAFFICO INTENSO
RECOMMENDED FOR ROADS WITH INTENSE TRAFFIC**

CODICE CODE	CLASSE CLASS	DIMENSIONI ESTERNE EXTERNAL DIMENSIONS	LUCE NETTA CLEAR OPENING	ALTEZZA HEIGHT	PESO TOTALE TOTAL WEIGHT	PEZZI PER PEDANA PIECES ON PALLET	NOTE NOTES	LISTINO PRICE LIST
		mm	mm	mm	Kg.	n.		€
RAF85D/COL	D400	850X850	Ø 600	100	95	10	TELAIO QUADRATO SQUARE FRAME	691,00
RAF95D/COL	D400	950X950	Ø 700	100	118	10	TELAIO QUADRATO SQUARE FRAME	858,00



RAFFAELLO SPARTAN



2025

GUARNIZIONE TRAPEZOIDALE
TRAPEZOIDAL CUSHIONING INSERT

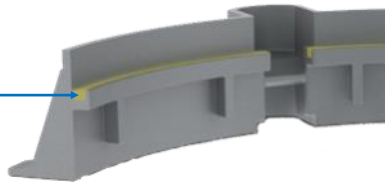

Chiusino in ghisa sferoidale GJS-500-7 - EN 1563 prodotto, secondo quanto sancito dall'ultima edizione in vigore delle norme UNI EN 124, da azienda certificata ISO 9001:2015, costituito da telaio, di forma quadrata/circolare/ottagonale alla base di appoggio e circolare alla sommità corrispondente al livello del piano stradale, munito di: adeguata aletta perimetrale esterna continua, di larghezza non inferiore a mm. 20 per ottenere una maggiore base di appoggio e consentire un migliore ancoraggio alla fondazione anche tramite apposite asole e/o fori creati sul perimetro;

battuta interna sagomata a "U"; guarnizione antirumore ed antibasculamento opportunamente sagomata per contrastare frontalmente il bordo del coperchio ed assorbire anche le vibrazioni; vano esterno a fondo chiuso, opportunamente dimensionato per l'inserimento di una leva per l'apertura, dotato di linguetta idonea ad accogliere l'appendice elastica del coperchio per il blocco del sistema di chiusura; vano cerniera a fondo chiuso con sistema di bloccaggio del coperchio in posizione di apertura. Coperchio di forma circolare, autocentrante nel telaio, munito di: sistema di chiusura formato da una appendice elastica opportunamente sagomata che si incastra sulla linguetta presente sul telaio e sbloccabile con qualsiasi leva; asola cieca idonea ad accogliere la leva per il sollevamento; appendice idonea a garantire l'articolazione del coperchio al telaio nel vano cerniera senza impedire la estraibilità del coperchio stesso; spazio circonferenziale e centrale per l'inserimento di eventuali scritte (es. ente appaltante + etc.); rilievi antisdrucciolo; particolare identificativo della forma esterna del telaio e delle dimensioni espresse in cm.

Tutti i coperchi ed i telai devono riportare la norma di riferimento, la classe di resistenza, il marchio del produttore in codice e la data del lotto di produzione.

Ductile iron GJS-500-7 - EN 1563 manhole cover, produced according to provisions of the latest edition of the UNI EN 124, by ISO 9001:2015 certified company, consists of a square/octagonal/circular frame as supporting base and circular at the top, corresponding to the street level, provided with: a continuous perimetral outer winglet, of a width not less than mm. 20, to obtain a greater supporting base and allow a better anchorage to the foundation also by elongated holes and/or holes created along the perimeter; "U" shaped internal seat; elastomeric cushioning insert, anti-noise and anti-rocking, suitably shaped to frontally withstand the edge of the cover and absorb vibrations; external compartment with closed bottom, suitably dimensioned for the insertion of an opening lever, provided with a jut for accommodating the elastic appendix of the cover and block the locking system; hinge housing with closed bottom and cover locking system in open position.

Cover of circular shape, self-centering in the frame, provided with: locking system formed by a suitably shaped elastic appendix which fits on tab on the frame and un-lockable with any lever; blind slot, for the inserting of the lifting keys; an appendix suitable to ensure the positioning of the cover to the frame in the hinge compartment without preventing the extractability of the cover; central and circumferential space for the insertion of any inscription (e.g. contractor entity + etc.); anti-slippery reliefs; identification of the outer shape of the frame and of the product size, expressed in cms. All covers and frames must display: the reference standard, the loading class, the mark of the manufacturer in code and the date of the batch.

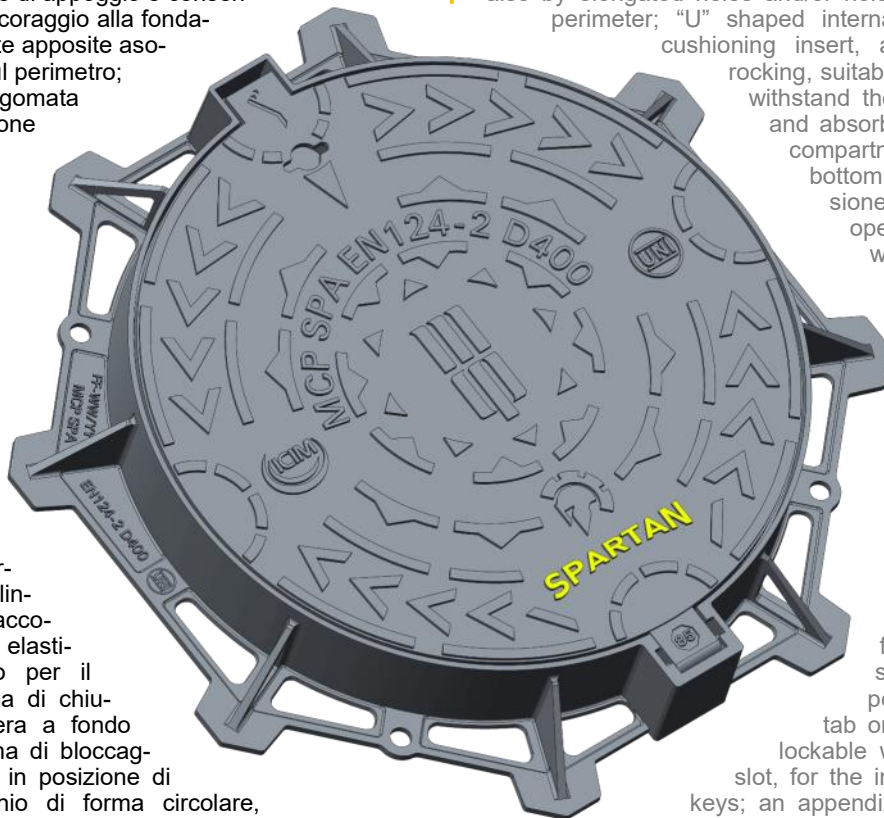

NEW PRODUCT

Chiusini in ghisa sferoidale
Ductile cast iron manhole tops

41



**CONSIGLIATI PER CARREGGIATE CON NORMALE TRAFFICO VEICOLARE
RECOMMENDED FOR STANDARD VEHICULAR TRAFFIC CARRIAGEWAYS**

CODICE	CLASSE	DIMENSIONI ESTERNE	LUCE NETTA	ALTEZZA	PESO TOTALE	PEZZI PER PEDANA	NOTE	LISTINO
CODE	CLASS	EXTERNAL DIMENSIONS	CLEAR OPENING	HEIGHT	TOTAL WEIGHT	PIECES ON PALLET	NOTES	PRICE LIST
		mm	mm	mm	Kg.	n.		€
RAF85D/T/SPA	D400	Ø 850	Ø 600	100	43	10	TELAIO OTTAGONALE OCTAGONAL FRAME	313,00

Certificazioni
Certifications



2025

Chiusini in ghisa sferoidale
Ductile cast iron manhole tops

42



Certificazioni
Certifications

RAFFAELLO ICON

Chiusino in ghisa sferoidale GJS-500-7 - EN 1563 prodotto, secondo quanto sancito dall'ultima edizione in vigore delle norme UNI EN 124, da azienda certificata ISO 9001:2015, costituito da telaio, di forma quadrata/circolare/ottagonale alla base di appoggio e circolare alla sommità corrispondente al livello del piano stradale, munito di: adeguata aletta perimetrale esterna continua, di larghezza non inferiore a mm. 20 per ottenere una maggiore base di appoggio e consentire un migliore ancoraggio alla fondazione anche tramite apposite asole e/o fori creati sul perimetro; battuta interna sagomata a "U"; guarnizione antirumore ed antibasculamento opportunamente sagomata per contrastare frontalmente il bordo del coperchio ed assorbire anche le vibrazioni; vano esterno a fondo chiuso, opportunamente dimensionato per l'inserimento di una leva per l'apertura, dotato di linguetta idonea ad accogliere l'appendice elastica del coperchio per il blocco del sistema di chiusura; vano cerniera a fondo chiuso con sistema di bloccaggio del coperchio in posizione di apertura. Coperchio di forma circolare, autocentrante nel telaio, munito di: sistema di chiusura formato da una appendice elastica opportunamente sagomata che si incastra sulla linguetta presente sul telaio e sbloccabile con qualsiasi leva; asola cieca idonea ad accogliere la leva per il sollevamento; appendice idonea a garantire l'articolazione del coperchio al telaio nel vano cerniera senza impedire la estraibilità del coperchio stesso; spazio circonferenziale e centrale per l'inserimento di eventuali scritte (es. ente appaltante + etc.); rilievi antisdrucciolo; particolare identificativo della forma esterna del telaio e delle dimensioni espresse in cm. Tutti i coperchi ed i telai devono riportare la norma di riferimento, la classe di resistenza, il marchio del produttore in codice e la data del lotto di produzione.

Ductile iron GJS-500-7 - EN 1563 manhole cover, produced according to provisions of the latest edition of the UNI EN 124, by ISO 9001:2015 certified company, consists of a square/octagonal/circular frame as supporting base and circular at the top, corresponding to the street level, provided with: a continuous perimetral outer winglet, of a width not less than mm. 20, to obtain a greater supporting base and allow a better anchorage to the foundation also by elongated holes and/or holes created along the perimeter; "U" shaped internal seat; elastomeric cushioning insert, anti-noise and anti-rocking, suitably shaped to frontally withstand the edge of the cover and absorb vibrations; external compartment with closed bottom, suitably dimensioned for the insertion an opening lever, provided with a jut for accommodating the elastic appendix of the cover and block the locking system; hinge housing with closed bottom and cover locking system in open position. Cover of circular shape, self-centering in the frame, provided with: locking system formed by a suitably shaped elastic appendix which fits on tab on the frame and unlockable with any lever; blind slot, for the inserting of the lifting keys; an appendix suitable to ensure the positioning of the cover to the frame in the hinge compartment without preventing the extractability of the cover; central and circumferential space for the insertion of any inscription (e.g. contractor entity + etc.); anti-slippery reliefs; identification of the outer shape of the frame and of the product size, expressed in cms. All covers and frames must display: the reference standard, the loading class, the mark of the manufacturer in code and the date of the batch.

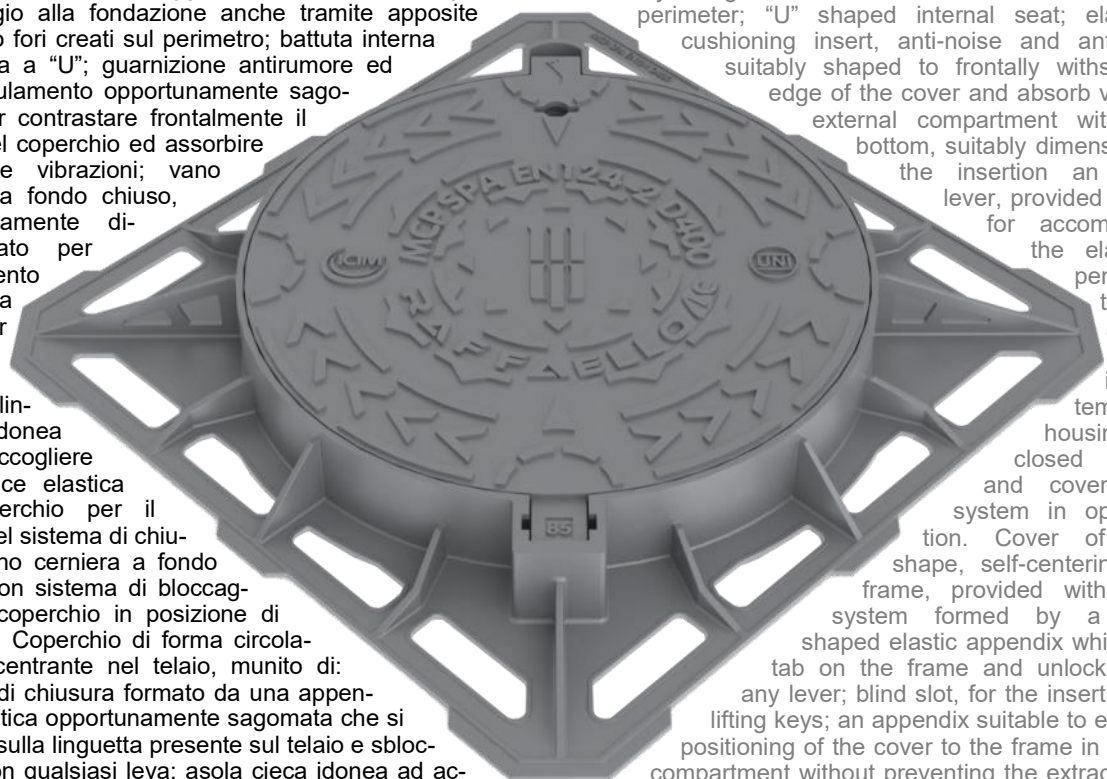

RAF85D/IC



RAF85D/T/IC



RAF85D/C/IC

Disponibilità immediata con le seguenti personalizzazioni:
Immediate availability with the following customization:

FOGNATURA

ACQUEDOTTO

ENEL CAVI ELETTRICI



RAFFAELLO ICON



2025

GUARNIZIONE TRAPEZOIDALE
TRAPEZOIDAL CUSHIONING INSERT

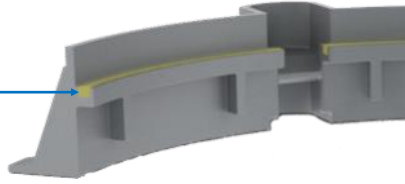

SISTEMA DI CHIUSURA AUTOMATICO

CODICE CODE	CLASSE CLASS	DIMENSIONI ESTERNE EXTERNAL DIMENSIONS mm	LUCE NETTA CLEAR OPENING mm	ALTEZZA HEIGHT mm	PESO TOTALE TOTAL WEIGHT Kg.	PEZZI PER PEDANA PIECES ON PALLET n.	NOTE NOTES	LISTINO PRICE LIST €
RAF75D/IC	D400	750X750	Ø 600	100	52	10	TELAIO QUADRATO SQUARE FRAME	407,00
RAF85D/IC	D400	850X850	Ø 600	100	54	10	TELAIO QUADRATO SQUARE FRAME	451,00
RAF85D/T/IC	D400	Ø 850	Ø 600	100	47	10	TELAIO OTTAGONALE OCTAGONAL FRAME	378,00
RAF85D/C/IC	D400	Ø 850	Ø 600	100	52	10	TELAIO CIRCOLARE ROUND FRAME	415,00
RAF95D/IC	D400	950X950	Ø 700	100	78	10	TELAIO QUADRATO SQUARE FRAME	650,00

Chiusini in ghisa sferoidale
Ductile cast iron manhole tops

43



SISTEMA DI CHIUSURA CON CHIAVE

CODICE CODE	CLASSE CLASS	DIMENSIONI ESTERNE EXTERNAL DIMENSIONS mm	LUCE NETTA CLEAR OPENING mm	ALTEZZA HEIGHT mm	PESO TOTALE TOTAL WEIGHT Kg.	PEZZI PER PEDANA PIECES ON PALLET n.	NOTE NOTES	LISTINO PRICE LIST €
RAF85F/IC	F900	850X850	Ø 600	100	92	8	TELAIO QUADRATO SQUARE FRAME	919,00
RAF95F/IC	F900	950X950	Ø 800	100	130	8	TELAIO QUADRATO SQUARE FRAME	1.282,00



Certificazioni
Certifications



2025

Chiusini in ghisa sferoidale
Ductile cast iron manhole tops

44



Certificazioni
Certifications

RAFFAELLO

Chiusino in ghisa sferoidale GJS-500-7 - EN 1563 prodotto, secondo quanto sancito dall'ultima edizione in vigore delle norme UNI EN 124, da azienda certificata ISO 9001:2015, costituito da telaio, di forma quadrata/circolare/ottagonale alla base di appoggio e circolare alla sommità corrispondente al livello del piano stradale, munito di: adeguata aletta perimetrale esterna continua, di larghezza non inferiore a mm. 20 per ottenere una maggiore base di appoggio e consentire un migliore ancoraggio alla fondazione anche tramite apposite asole e/o fori creati sul perimetro; battuta interna sagomata a "U"; guarnizione antirumore ed antibasculamento opportunamente sagomata per contrastare frontalmente il bordo del coperchio ed assorbire anche le vibrazioni; vano esterno a fondo chiuso, opportunamente dimensionato per l'inserimento di una leva per l'apertura, dotato di linguetta idonea ad accogliere l'appendice elastica del coperchio per il blocco del sistema di chiusura; vano cerniera a fondo chiuso con sistema di bloccaggio del coperchio in posizione di apertura. Coperchio di forma circolare, autocentrante nel telaio, munito di: sistema di chiusura formato da una appendice elastica opportunamente sagomata che si incastra sulla linguetta presente sul telaio e sbloccabile con qualsiasi leva; asola cieca idonea ad accogliere la leva per il sollevamento; appendice idonea a garantire l'articolazione del coperchio al telaio nel vano cerniera senza impedire la estraibilità del coperchio stesso; spazio circonferenziale e centrale per l'inserimento di eventuali scritte (es. ente appaltante + etc.); rilievi antisdrucchiolo; particolare identificativo della forma esterna del telaio e delle dimensioni espresse in cm. Tutti i coperchi ed i telai devono riportare la norma di riferimento, la classe di resistenza, il marchio del produttore in codice e la data del lotto di produzione.

Ductile iron GJS-500-7 - EN 1563 manhole cover, produced according to provisions of the latest edition of the UNI EN 124, by ISO 9001:2015 certified company, consists of a square/octagonal/circular frame as supporting base and circular at the top, corresponding to the street level, provided with: a continuous perimetral outer winglet, of a width not less than mm. 20, to obtain a greater supporting base and allow a better anchorage to the foundation also by elongated holes and/or holes created along the perimeter; "U" shaped internal seat; elastomeric cushioning insert, anti-noise and anti-rocking, suitably shaped to frontally withstand the edge of the cover and absorb vibrations; external compartment with closed bottom, suitably dimensioned for the insertion of an opening lever, provided with a jut for accommodating the elastic appendix of the cover and block the locking system; hinge housing with closed bottom and cover locking system in open position. Cover of circular shape, self-centering in the frame, provided with: locking system formed by a suitably shaped elastic appendix which fits on the frame and unlockable with any lever; blind slot, for the inserting of the lifting keys; an appendix suitable to ensure the positioning of the cover to the frame in the hinge compartment without preventing the extractability of the cover; central and circumferential space for the insertion of any inscription (e.g. contractor entity + etc.); anti-slippery reliefs; identification of the outer shape of the frame and of the product size, expressed in cms. All covers and frames must display: the reference standard, the loading class, the mark of the manufacturer in code and the date of the batch.

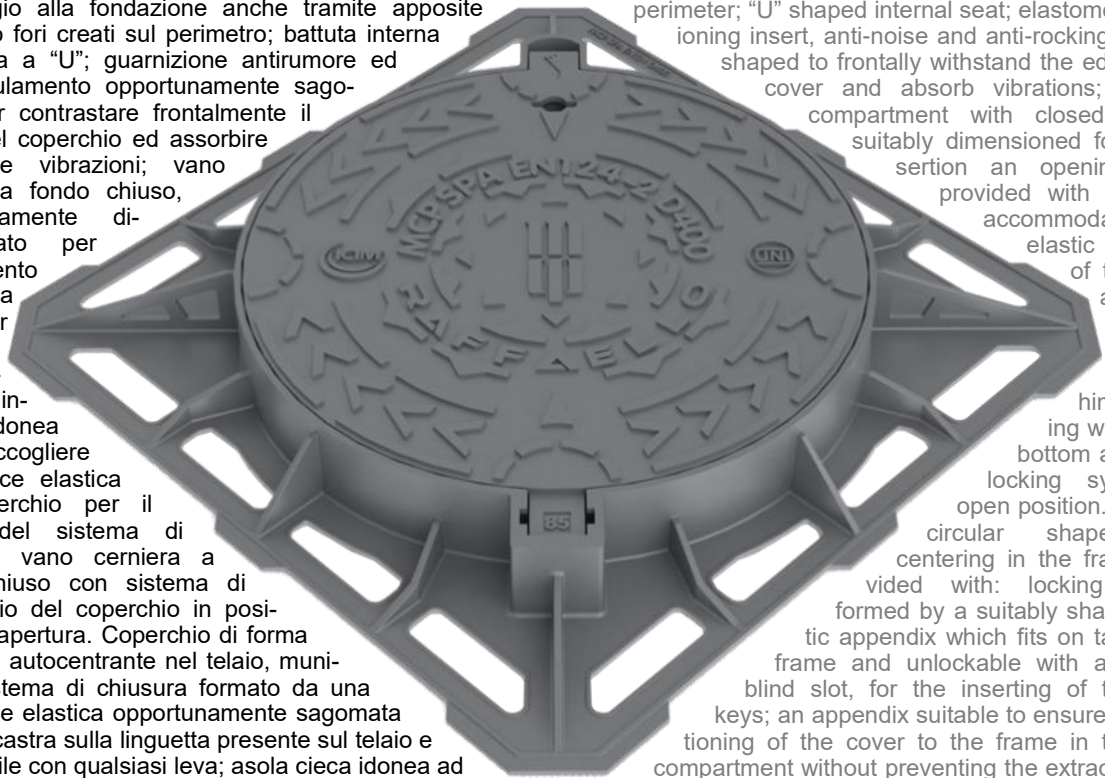

RAFF85D



RAFF85D/T



RAFF85D/C

Disponibilità immediata con le seguenti personalizzazioni:
Immediate availability with the following customization:

FOGNATURA

ACQUEDOTTO

ENEL CAVI ELETTRICI



GUARNIZIONE TRAPEZOIDALE
TRAPEZOIDAL CUSHIONING INSERT

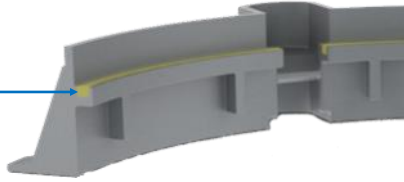

RAFFAELLO



2025

SISTEMA DI CHIUSURA AUTOMATICO

CODICE CODE	CLASSE CLASS	DIMENSIONI ESTERNE EXTERNAL DIMENSIONS mm	LUCE NETTA CLEAR OPENING mm	ALTEZZA HEIGHT mm	PESO TOTALE TOTAL WEIGHT Kg.	PEZZI PER PEDANA PIECES ON PALLET n.	NOTE NOTES	LISTINO PRICE LIST €
RAF75D	D400	750X750	Ø 600	100	56	10	TELAIO QUADRATO SQUARE FRAME	407,00
RAF85D	D400	850X850	Ø 600	100	62	10	TELAIO QUADRATO SQUARE FRAME	451,00
RAF85D/T	D400	Ø 850	Ø 600	100	52	10	TELAIO OTTAGONALE OCTAGONAL FRAME	378,00
RAF85D/TV	D400	Ø 850	Ø 600	100	52	10	TELAIO OTTAGONALE OCTAGONAL FRAME	378,00
RAF85D/C	D400	Ø 850	Ø 600	100	57	10	TELAIO CIRCOLARE ROUND FRAME	415,00
RAF95D	D400	950X950	Ø 700	100	85	10	TELAIO QUADRATO SQUARE FRAME	650,00



COPERCHIO VENTILATO
VENTILATED COVER

Chiusini in ghisa sferoidale
Ductile cast iron manhole tops

COPERCHIO VENTILATO
VENTILATED COVER



45



SISTEMA DI CHIUSURA CON CHIAVE

CODICE CODE	CLASSE CLASS	DIMENSIONI ESTERNE EXTERNAL DIMENSIONS mm	LUCE NETTA CLEAR OPENING mm	ALTEZZA HEIGHT mm	PESO TOTALE TOTAL WEIGHT Kg.	PEZZI PER PEDANA PIECES ON PALLET n.	NOTE NOTES	LISTINO PRICE LIST €
RAF85E	E600	850X850	Ø 600	100	82	10	TELAIO QUADRATO SQUARE FRAME	746,00
RAF85F	F900	850X850	Ø 600	100	101	8	TELAIO QUADRATO SQUARE FRAME	919,00
RAF95F	F900	950X950	Ø 800	100	141	8	TELAIO QUADRATO SQUARE FRAME	1.282,00



Certificazioni
Certifications



2025

Chiusini in ghisa sferoidale
Ductile cast iron manhole tops

46



Certificazioni
Certifications

GIOTTO ICON

Chiusino in ghisa sferoidale GJS-500-7 - EN 1563 prodotto, secondo quanto sancito dall'ultima edizione in vigore delle norme UNI EN 124, classe di carrabilità D400, da azienda certificata ISO 9001:2015, costituito da telaio, di forma quadrata/ottagonale alla base di appoggio e circolare alla sommità corrispondente al livello del piano stradale, munito di: adeguata aletta perimetrale esterna continua, di larghezza non inferiore a mm. 20 per ottenere una maggiore base di appoggio e consentire un migliore ancoraggio alla fondazione anche tramite apposite asole e/o fori creati sul perimetro e mediante l'utilizzo di eventuali mezzi meccanici di fissaggio al pozzetto; battuta interna sagomata a "U"; guarnizione in elastomero antirumore ed antibasculamento per contrastare frontalmente il bordo del coperchio ed assorbirne anche le vibrazioni; vano cerniera a fondo chiuso con sistema di bloccaggio del coperchio in posizione di apertura. Coperchio di forma circolare, autocentrante nel telaio, munito di: asola idonea ad accogliere la chiave di apertura e sollevamento; sistema di chiusura in acciaio realizzato mediante chiavistello rotante bullonato con molla elicoidale di contrasto; appendice idonea a garantire l'articolazione del coperchio al telaio nel vano cerniera senza impedire la estraibilità del coperchio stesso; spazio circonferenziale e centrale per l'inserimento di eventuali scritte o loghi (es. ente appaltante + etc.); particolare identificativo delle dimensioni e della forma esterna del telaio espresse in cm; rilievi anti-sdrucchiolo. Tutti i coperchi ed i telai devono riportare la norma di riferimento, la classe di resistenza, il marchio del produttore in codice e la data del lotto di produzione.



Ductile iron GJS-500-7 - EN 1563 manhole cover, produced according to provisions of the latest edition of the UNI EN 124, loading class D400, by ISO 9001:2015 certified company, consists of a square/octagonal frame, as supporting base and circular at the top, corresponding to the street level, provided with: a continuous perimetral outer winglet of a width not less than mm. 20, to obtain a greater supporting base and allow a better anchorage to the foundation also by means of elongated holes and/or holes created along the perimeter and through the use of any mechanical means for fixing to the manhole; "U" shaped internal seat; elastomeric cushioning insert, anti-noise and anti-rocking, suitably shaped to frontally withstand the edge of the cover and absorb vibrations; hinge housing with closed bottom and cover locking system in open position. Cover of circular shape, self-centering in the frame, provided with: slot, for the inserting of the opening and lifting key, locking system in steel realized by means of a rotating bolt, bolted with helical spring of contrast; an appendix suitable to ensure the positioning of the cover to the frame in the hinge compartment without preventing the extractability of the cover; central and circumferential space for the insertion of any inscription (e.g. contractor entity + etc.); identification of the outer shape of the frame and of the product size, expressed in cms.; anti-slippery reliefs.

All covers and frames must display: the reference standard, the loading class, the mark of the manufacturer in code and the date of the batch.



**CONSIGLIATI PER CARREGGIATE CON NORMALE TRAFFICO VEICOLARE
RECOMMENDED FOR STANDARD VEHICULAR TRAFFIC CARRIAGEWAYS**

Disponibilità immediata con le seguenti personalizzazioni:
Immediate availability with the following customization:

FOGNATURA

ACQUEDOTTO

ENEL CAVI ELETTRICI



GIOTTO ICON

Telaio Quadrato



2025

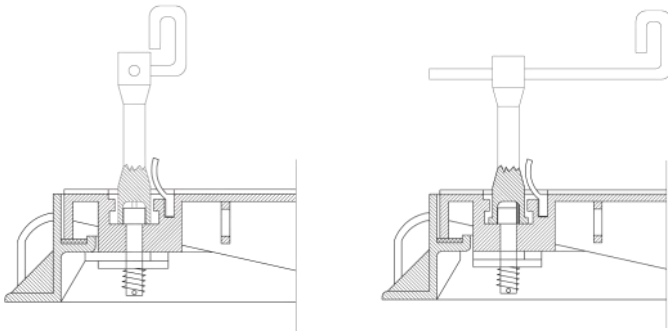

GIO80D/IC

CODICE CODE	CLASSE CLASS	DIMENSIONI ESTERNE EXTERNAL DIMENSIONS mm	LUCE NETTA CLEAR OPENING mm	ALTEZZA HEIGHT mm	PESO TOTALE TOTAL WEIGHT Kg.	PEZZI PER PEDANA PIECES ON PALLET n.	NOTE NOTES	LISTINO PRICE LIST €
GIO50D/IC	D400	500X500	Ø 400	85	28	24	TELAIO QUADRATO SQUARE FRAME	204,00
GIO60D/IC	D400	600X600	Ø 500	85	37,5	20	TELAIO QUADRATO SQUARE FRAME	273,00
GIO70D/IC	D400	700X700	Ø 600	85	47	6	TELAIO QUADRATO SQUARE FRAME	371,00
GIO80D/IC	D400	800X800	Ø 600	85	52	6	TELAIO QUADRATO SQUARE FRAME	407,00
GIO90D/IC	D400	900X900	Ø 700	100	73	10	TELAIO QUADRATO SQUARE FRAME	582,00
GIO100D/IC	D400	1000X1000	Ø 800	100	95	10	TELAIO QUADRATO SQUARE FRAME	862,00
GIO110D/IC	D400	1100X1100	Ø 1000	100	131	10	TELAIO QUADRATO SQUARE FRAME	1.155,00

Chiusini in ghisa sferoidale
Ductile cast iron manhole tops

47

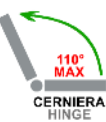

GIOTTO ICON

Telaio Ottagonale

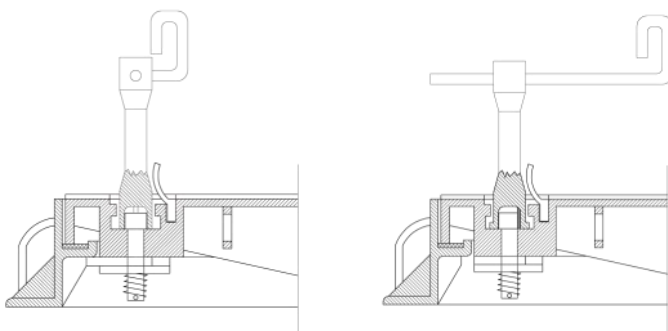

GIO80D/T/IC

CODICE CODE	CLASSE CLASS	DIMENSIONI ESTERNE EXTERNAL DIMENSIONS mm	LUCE NETTA CLEAR OPENING mm	ALTEZZA HEIGHT mm	PESO TOTALE TOTAL WEIGHT Kg.	PEZZI PER PEDANA PIECES ON PALLET n.	NOTE NOTES	LISTINO PRICE LIST €
GIO50D/T/IC	D400	Ø 500	Ø 400	85	26	24	TELAIO OTTAGONALE OCTAGONAL FRAME	189,00
GIO60D/T/IC	D400	Ø 600	Ø 500	85	35	20	TELAIO OTTAGONALE OCTAGONAL FRAME	255,00
GIO70D/T/IC	D400	Ø 700	Ø 600	85	44	6	TELAIO OTTAGONALE OCTAGONAL FRAME	342,00
GIO80D/T/IC	D400	Ø 800	Ø 600	85	48	6	TELAIO OTTAGONALE OCTAGONAL FRAME	371,00

Certificazioni
Certifications



2025

Chiusini in ghisa sferoidale
Ductile cast iron manhole tops

48



Certificazioni
Certifications

GIOTTO

Chiusino in ghisa sferoidale GJS-500-7 - EN 1563 prodotto, secondo quanto sancito dall'ultima edizione in vigore delle norme UNI EN 124, classe di carrabilità D400, da azienda certificata ISO 9001:2015, costituito da telaio, di forma quadrata/ottagonale alla base di appoggio e circolare alla sommità corrispondente al livello del piano stradale, munito di: adeguata aletta perimetrale esterna continua, di larghezza non inferiore a mm. 20 per ottenere una maggiore base di appoggio e consentire un migliore ancoraggio alla fondazione anche tramite apposite asole e/o fori creati sul perimetro e mediante l'utilizzo di eventuali mezzi meccanici di fissaggio al pozzetto; battuta interna sagomata a "U"; guarnizione in elastomero antirumore ed antibasculamento per contrastare frontalmente il bordo del coperchio ed assorbirne anche le vibrazioni; vano cerniera a fondo chiuso con sistema di bloccaggio del coperchio in posizione di apertura. Coperchio di forma circolare, autocentrante nel telaio, munito di: asola idonea ad accogliere la chiave di apertura e sollevamento; sistema di chiusura in acciaio realizzato mediante chiovistello rotante bullonato con molla elicoidale di contrasto; appendice idonea a garantire l'articolazione del coperchio al telaio nel vano cerniera senza impedire la estraibilità del coperchio stesso; spazio circonferenziale e centrale per l'inserimento di eventuali scritte e/o loghi (es. ente appaltante + etc.); particolare identificativo delle dimensioni e della forma esterna del telaio espresse in cm; rilievi anti-sdrucchiolo. Tutti i coperchi ed i telai devono riportare la norma di riferimento, la classe di resistenza, il marchio del produttore in codice e la data del lotto di produzione.



Ductile iron GJS-500-7 - EN 1563 manhole cover, produced according to provisions of the latest edition of the UNI EN 124, loading class D400, by ISO 9001:2015 certified company, consists of a square/octagonal frame, as supporting base and circular at the top, corresponding to the street level, provided with: a continuous perimetral outer winglet of a width not less than mm. 20, to obtain a greater supporting base and allow a better anchorage to the foundation also by means of elongated holes and/or holes created along the perimeter and through the use of any mechanical means for fixing to the manhole; "U" shaped internal seat; elastomeric cushioning insert, anti-noise and anti-rocking, suitably shaped to frontally withstand the edge of the cover and absorb vibrations; hinge housing with closed bottom and cover locking system in open position. Cover of circular shape, self-centering in the frame, provided with: slot, for the inserting of the opening and lifting key, locking system in steel realized by means of a rotating bolt, bolted with helical spring of contrast; an appendix suitable to ensure the positioning of the cover to the frame in the hinge compartment without preventing the extractability of the cover; central and circumferential space for the insertion of any inscription (e.g. contractor entity + etc.); identification of the outer shape of the frame and of the product size, expressed in cms.; anti-slippery reliefs. All covers and frames must display: the reference standard, the loading class, the mark of the manufacturer in code and the date of the batch.

CONSIGLIATI PER CARREGGIATE CON NORMALE TRAFFICO VEICOLARE
RECOMMENDED FOR STANDARD VEHICULAR TRAFFIC CARRIAGEWAYS

Disponibilità immediata con le seguenti personalizzazioni:
Immediate availability with the following customization:

FOGNATURA

ACQUEDOTTO

ENEL CAVI ELETTRICI



GIOTTO

Telaio Quadrato



2025

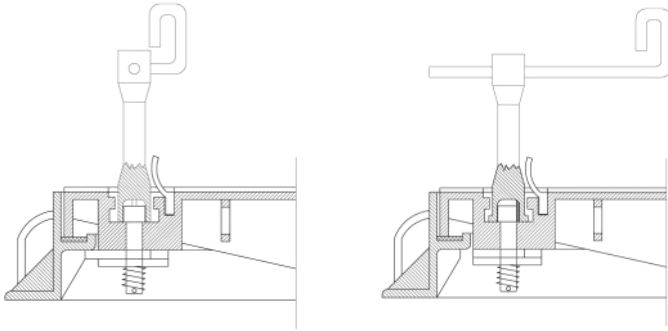

GIO80D

CODICE CODE	CLASSE CLASS	DIMENSIONI ESTERNE EXTERNAL DIMENSIONS mm	LUCE NETTA CLEAR OPENING mm	ALTEZZA HEIGHT mm	PESO TOTALE TOTAL WEIGHT Kg.	PEZZI PER PEDANA PIECES ON PALLET n.	NOTE NOTES	LISTINO PRICE LIST €
GIO50D	D400	500X500	Ø 400	85	29	24	TELAIO QUADRATO SQUARE FRAME	236,00
GIO60D	D400	600X600	Ø 500	85	40	20	TELAIO QUADRATO SQUARE FRAME	326,00
GIO70D	D400	700X700	Ø 600	85	51	6	TELAIO QUADRATO SQUARE FRAME	371,00
GIO80D	D400	800X800	Ø 600	85	56	6	TELAIO QUADRATO SQUARE FRAME	407,00
GIO90D	D400	900X900	Ø 700	100	80	10	TELAIO QUADRATO SQUARE FRAME	582,00
GIO100D	D400	1000X1000	Ø 800	100	106	10	TELAIO QUADRATO SQUARE FRAME	862,00
GIO110D	D400	1100X1100	Ø 1000	100	142	10	TELAIO QUADRATO SQUARE FRAME	1.155,00

Chiusini in ghisa sferoidale
Ductile cast iron manhole tops

49



GIOTTO

Telaio Ottagonale

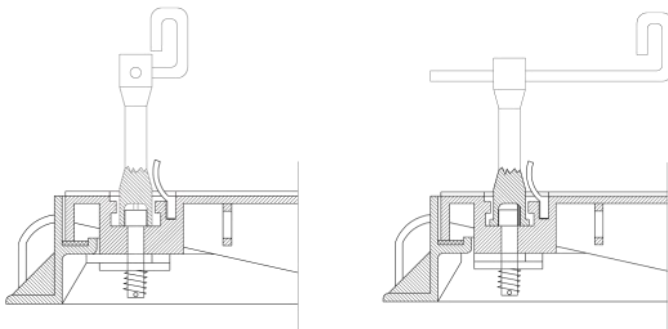

GIO80D/T

CODICE CODE	CLASSE CLASS	DIMENSIONI ESTERNE EXTERNAL DIMENSIONS mm	LUCE NETTA CLEAR OPENING mm	ALTEZZA HEIGHT mm	PESO TOTALE TOTAL WEIGHT Kg.	PEZZI PER PEDANA PIECES ON PALLET n.	NOTE NOTES	LISTINO PRICE LIST €
GIO60D/T	D400	Ø 600	Ø 500	85	37	20	TELAIO OTTAGONALE OCTAGONAL FRAME	301,00
GIO70D/T	D400	Ø 700	Ø 600	85	47	6	TELAIO OTTAGONALE OCTAGONAL FRAME	342,00
GIO80D/T	D400	Ø 800	Ø 600	85	51	6	TELAIO OTTAGONALE OCTAGONAL FRAME	371,00

Certificazioni
Certifications



2025

Chiusini in ghisa sferoidale
Ductile cast iron manhole tops

50



Certificazioni
Certifications

CSUNI



CSUNI/9



**NEW
PRODUCT**

CHIUSINI per SARACINESCHE

CHIUSINI per **SARACINESCHE** con coperchi vincolati nelle modalità indicate nelle note e asole centrali per il sollevamento.

CSUNI/4 con scritta **ACQUA**.

CSUNI/7 con scritta **GAS**.

Surface boxes, with covers constrained to the frames in different modality as specified in the notes and with slots for lifting it up.



CSUNI/1

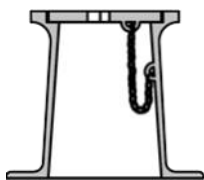

CSUNI/2



CSUNI/4

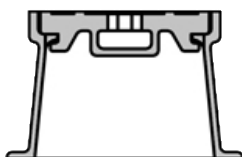

CSUNI/7

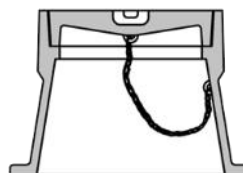

CODICE	CLASSE	DIMENSIONI ESTERNE	LUCE NETTA	ALTEZZA	PESO TOTALE	PEZZI PER PEDANA	NOTE	LISTINO
CODE	CLASS	EXTERNAL DIMENSIONS	CLEAR OPENING	HEIGHT	TOTAL WEIGHT	PIECES ON PALLET	NOTES	PRICE LIST
		mm	mm	mm	Kg.	n.		€
CSUNI/1		Ø 214	Ø 100	180	6,5	125	CON CATENA WITH CHAIN	65,00
CSUNI/2	D400	Ø 240	Ø 100	220	9	125	CON CATENA WITH CHAIN	89,00
CSUNI/4		Ø 210	Ø 120	130	6,1	125	COPERCHIO AD INCASTRO DAP JOINT COVER	61,00
CSUNI/7	D400	Ø 350	Ø 200	230	27	36	CON CATENA WITH CHAIN	267,00
CSUNI/9		320X320	150X150	100	18	45	2 COPERCHI TRIANGOLARI 2 Triangular COVERS	178,00

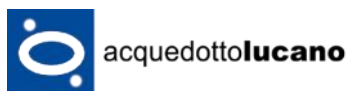

CHIUSINI per IDRANTI SOTTOSUOLO

CHIUSINI per IDRANTI SOTTOSUOLO con coperchi con asola centrale chiusa e vite laterale passante di collegamento al telaio. I coperchi sono forniti con la scritta **IDRANTE**.

Surface boxes for UNDERGROUND HYDRANT provided with covers with central blind elongated hole, and passing side screw for link it to the frame.

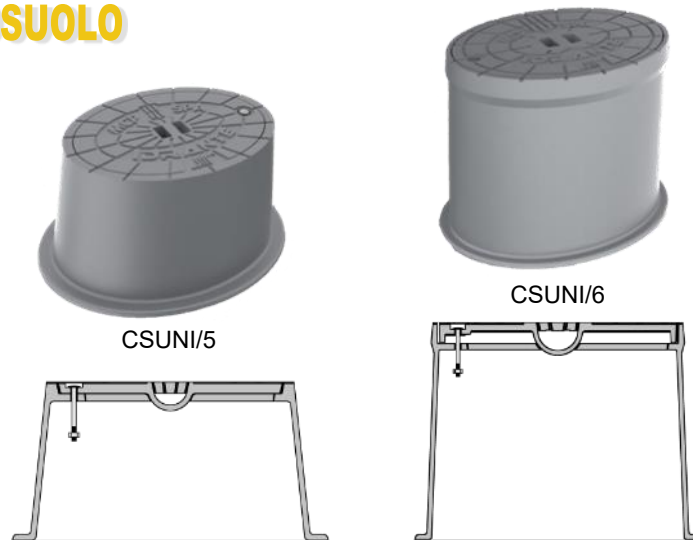

CODICE CODE	CLASSE CLASS	DIMENSIONI ESTERNE EXTERNAL DIMENSIONS mm	LUCE NETTA CLEAR OPENING mm	ALTEZZA HEIGHT mm	PESO TOTALE TOTAL WEIGHT Kg.	PEZZI PER PEDANA PIECES ON PALLET n.	NOTE NOTES	LISTINO PRICE LIST €
CSUNI/5		310X400	170X237	200	17	45	CON BULLONE WITH BOLT	168,00
CSUNI/6		310X410	213X285	310	26	45	CON BULLONE WITH BOLT	257,00

Chiusini in ghisa sferoidale
Ductile cast iron manhole tops



CARATTERISTICHE:

- ⇒ Carico di rottura > 400kN
Breaking load > 400kN
- ⇒ Telaio tondo senza aletta perimetrale esterna.
Round frame without perimetric outer winglet.
- ⇒ Guarnizione in elastomero incassata nel telaio che garantisce silenziosità e stabilità.
Elastomeric cushioning insert encased on the frame to guarantee silence and stability.
- ⇒ Blocco del coperchio a 90°.
Safety cover stop at 90°.
- ⇒ Identificazioni dimensionale del prodotto.
Identification of the product size.



MUNCH

CODICE CODE	CLASSE CLASS	DIMENSIONI ESTERNE EXTERNAL DIMENSIONS mm	LUCE NETTA CLEAR OPENING mm	ALTEZZA HEIGHT mm	PESO TOTALE TOTAL WEIGHT Kg.	PEZZI PER PEDANA PIECES ON PALLET n.	NOTE NOTES	LISTINO PRICE LIST €
MUN78D/V	D400	Ø 785	Ø 625	100	76	6	VENTILATO VENTILATED	331,00



2025

Chiusini in ghisa sferoidale
Ductile cast iron manhole tops

52



Certificazioni
Certifications

MODIGLIANI

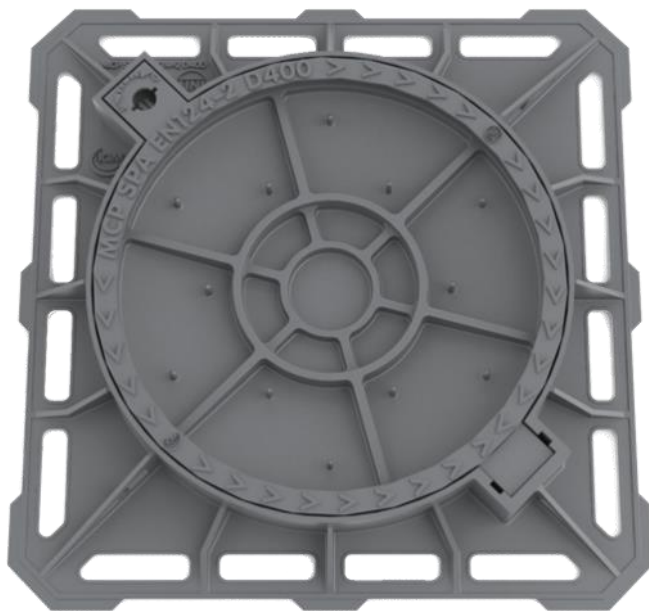

MOD85D

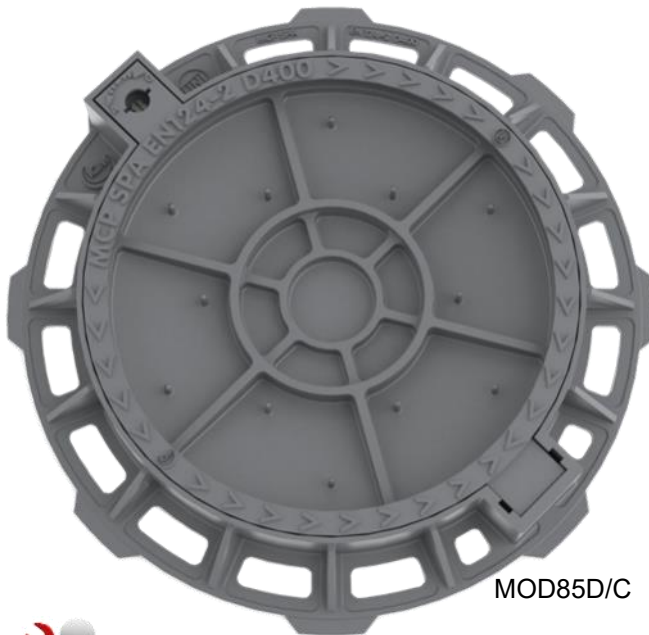

MOD85D/C



RIEMPIMENTO DEI COPERCHI CON IL CALCESTRUZZO FILLING OF THE COVERS WITH CONCRETE

Il riempimento in calcestruzzo dei coperchi di chiusini tipo Modigliani impone soprattutto nei luoghi di posa in cui vi sono elevati sbalzi di temperatura o che presuppongono un impiego particolarmente gravoso per i chiusini l'esecuzione secondo determinate regole. La superficie interna dei coperchi dovrà essere scevra da ogni residuo che possa compromettere la presa del calcestruzzo (olio, grasso, sabbia, etc.). Il calcestruzzo dovrà essere gettato ad una temperatura non inferiore a 10° C. Il riempimento va eseguito in giusta misura e livellato opportunamente. Mantenere la stessa scabrosità della carreggiata. Dopo il riempimento, per le prime 24 ore di maturazione è opportuno coprire con un telo il getto evitando l'essiccamento rapido. Se la temperatura esterna è inferiore a 10° C la protezione dovrà mantenersi per le prime 48 ore. Per la maturazione del calcestruzzo seguire i tempi e le istruzioni d'uso indicate dal fabbricante delle malte.



CARATTERISTICHE:

- ⇒ Carico di rottura > 400kN
Breaking load > 400kN
- ⇒ Ideale per pavimentazioni lastricate e porfidi.
Ideal for porphyry paving.
- ⇒ Telaio con aletta perimetrale esterna, continua sui quattro lati, con asole e/o fori per una maggiore base di appoggio e un migliore ancoraggio alla fondazione.
Frame with a outer winglet along the four sides with elongated holes and or holes for a greater supporting base and a better anchorage to the foundation.
- ⇒ Guarnizione in elastomero incassata nel telaio che garantisce silenziosità e stabilità.
Elastomeric cushioning insert fitted into the frame to guarantee silence and stability.
- ⇒ Blocco del coperchio a 90°.
Safety cover stop at 90°.
- ⇒ Identificazioni dimensionale del prodotto.
Identification of the product size.



The filling of the manhole tops model Modigliani must be performed according to certain statements, mainly on the laying sites submitted to sudden temperature changes, or requiring a very stressed utilization of the device. The internal surface of the covers must be free of any residual that may compromise the setting of the mortar (oil, grease, ands ecc), The mortar must be filled at a temperature not lower than 10° C, in the right measure and duly levelled. The same roughness of the pavement must be preserved. The covering of the device with a sheet , for the first 24 hours of aging, is appropriated to avoid a fast hardening. Should the temperature be lower than 10° C, the protection must be kept for the first 48 hours. The aging of the mortar must be performed according to the times and instructions given by the mortar producer.

CODICE	CLASSE	DIMENSIONI ESTERNE	LUCE NETTA	ALTEZZA	PESO TOTALE	PEZZI PER PEDANA	NOTE	LISTINO
CODE	CLASS	EXTERNAL DIMENSIONS	CLEAR OPENING	HEIGHT	TOTAL WEIGHT	PIECES ON PALLET	NOTES	PRICE LIST
		mm	mm	mm	Kg.	n.		€
MOD85D	D400	850X850	Ø 600	100	66	10	PROFONDITA' MAX 77mm MAX 77mm INTERNAL DEPTH	651,00
MOD85D/C	D400	Ø 850	Ø 600	100	60	10	PROFONDITA' MAX 77mm MAX 77mm INTERNAL DEPTH	592,00



CARATTERISTICHE:

- ⇒ Carico di rottura > 400kN
 Breaking load > 400kN
- ⇒ Telaio con aletta perimetrale esterna continua con asole e/o fori per una maggiore base di appoggio e un migliore ancoraggio alla fondazione.
 Frame with a continuous outer winglet with elongated holes and or holes for a greater supporting base and a better anchorage to the foundation.
- ⇒ Doppia guarnizione in elastomero incassata nel telaio che garantisce la tenuta stagna, la silenziosità e la stabilità.
 Double elastomeric seal fitted into the frame that ensures watertightness quietness and stability.
- ⇒ Coperchio con doppia battuta bullonato al telaio in tre punti con asole cieche per il sollevamento.
 Double seal cover bolted to the frame in 3 spots with blind holes for lifting it up.
- ⇒ Identificazione dimensionale del prodotto.
 Identification of the product size.

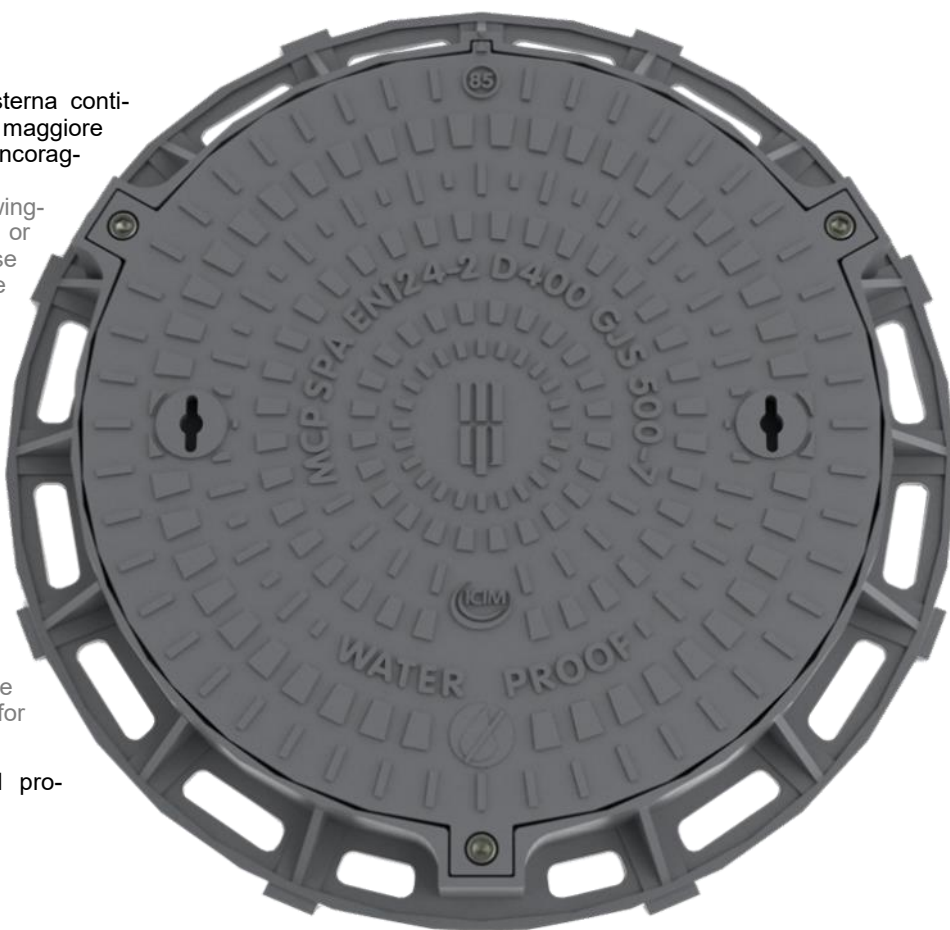

Chiusini in ghisa sferoidale
 Ductile cast iron manhole tops

53

DOPPIA GUARNIZIONE IN ELASTOMERO

DOUBLE ELASTOMERIC SEAL FITTED INTO

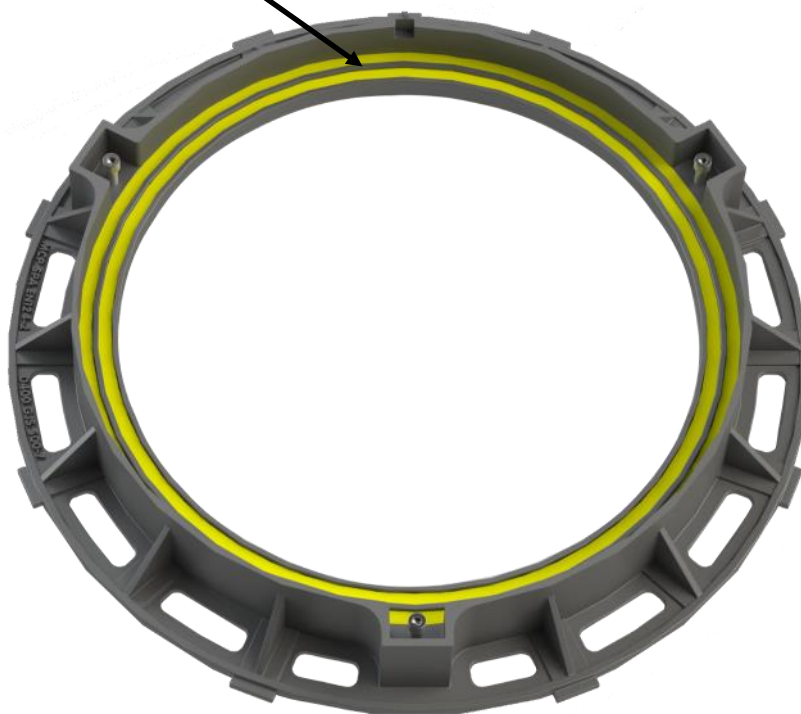

CODICE	CLASSE	DIMENSIONI ESTERNE	LUCE NETTA	ALTEZZA	PESO TOTALE	PEZZI PER PEDANA	NOTE	LISTINO
CODE	CLASS	EXTERNAL DIMENSIONS	CLEAR OPENING	HEIGHT	TOTAL WEIGHT	PIECES ON PALLET	NOTES	PRICE LIST
		mm	mm	mm	Kg.	n.		€
HID85D	D400	Ø 850	Ø 600	100	84	10	TENUTA STAGNA WATERTIGHT	911,00



Certificazioni
Certifications



2025

Chiusini in ghisa sferoidale
Ductile cast iron manhole tops

54



Certificazioni
Certifications

DALI' VENTILATO

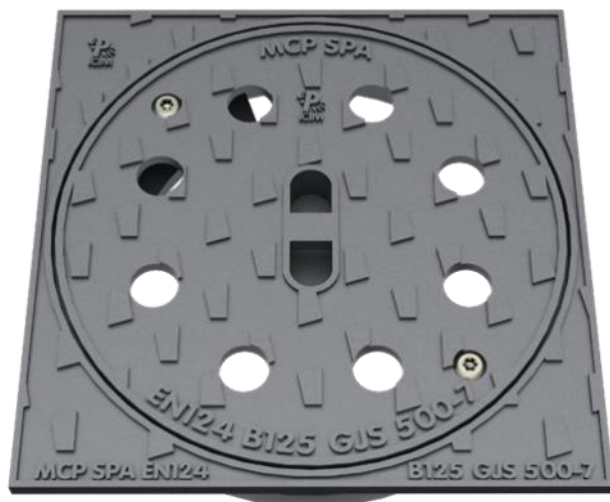

CSTB34/V

CARATTERISTICHE:

- ⇒ Carico di rottura > 125kN per la classe **B125**
> 400kN per la classe **D400**
- Breaking load > 125kN for class **B125**
> 400kN for class **D400**
- ⇒ Coperchio bullonato al telaio.
Cover with bolts.
- ⇒ Idoneo per innesto su tubo in PVC DN 300.
Suitable for insertion into PVC DN 300 pipes.



CSTTD48

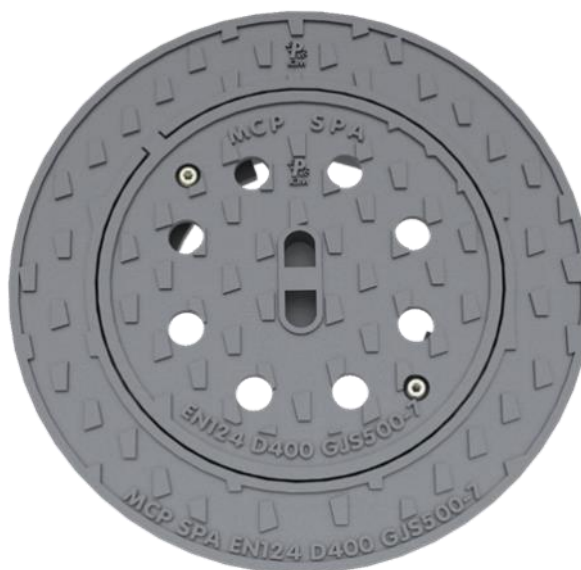

CSTTD48/V

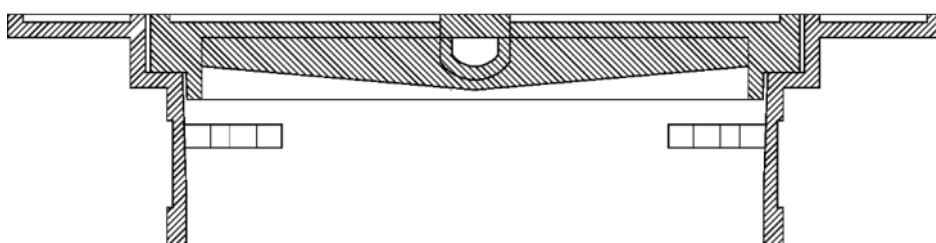

CSTTD48/V

CODICE CODE	CLASSE CLASS	DIMENSIONI ESTERNE EXTERNAL DIMENSIONS mm	LUCE NETTA CLEAR OPENING mm	ALTEZZA HEIGHT mm	PESO TOTALE TOTAL WEIGHT Kg.	PEZZI PER PEDANA PIECES ON PALLET n.	NOTE NOTES	LISTINO PRICE LIST €
CSTB34/V	B125	340X340	Ø 226	66	13	81	VENTILATO VENTILATED	57,00
CSTTD48	D400	Ø 484	Ø 226	120	28	32		123,00
CSTTD48/V	D400	Ø 484	Ø 226	120	28	32	VENTILATO VENTILATED	123,00

SICURI E GARANTITI IN OGNI STAGIONE.
SAFE AND GUARANTEED FOR ALL SEASONS.



CADITOIE IN GHISA SFEROIDALE



DUCTILE CAST IRON GULLY TOPS



TAMPONS D'ÉGOUT IN FONTE DUCTILE



SCHACHTABDECKUNGEN AUS DUKTILEM GUBEISEN



REJAS EN FUNDICIÓN DÚCTIL



Designed by MCP SPA® in Italy



2025

Caditoie in ghisa sferoidale
Ductile cast iron gully tops

56



Certificazioni
Certifications

MICHELANGELO ICON

Caditoia, modello **ICON**, in ghisa sferoidale GJS-500-7 – EN 1563 prodotta, secondo quanto sancito dall'ultima edizione della norma UNI EN 124, da azienda certificata ISO 9001:2015, costituita da telaio di forma quadrata sia alla base di appoggio che alla sommità corrispondente al livello del piano stradale, munito di: adeguata aletta perimetrale esterna, continua sui quattro lati, opportunamente sagomata, arrotondata agli angoli, per ottenere una maggiore base di appoggio e consentire un migliore ancoraggio alla fondazione anche mediante fori/asole utili al fissaggio con tirafondi; costole di rinforzo; fori per l'articolazione della griglia; alette interne predisposte ai quattro angoli per l'alloggio di un sifone. Griglia di forma quadrata munita di: fori per l'articolazione al telaio; sistema di chiusura formato da appendici elastiche opportunamente sagomate che si incastrano con le linguette presenti sul telaio e sbloccabile con una leva generica; asole parallele disposte su due o più file; coppia di dadi e bulloni opportunamente inseriti negli appositi fori onde consentire l'articolazione della griglia al telaio ed evitare il furto e/o la manomissione; concavità centrale, ove prevista, per realizzare la minima pendenza utile sull'estradosso; rilievi antisdrucchiolo. Tutte le griglie ed i telai devono riportare la norma di riferimento, la classe di resistenza, il marchio del produttore in codice e la data del lotto di produzione.

Ductile cast iron GJS/500/7 - EN 1563 gully top, **ICON** model, produced, according to provisions of UNI EN 124 latest edition, by ISO 9001:2015 certified company, consisting of a square frame at both the supporting base and top corresponding to the street level, provided with: specific outer continuous winglet with round corners on all four sides, in order to supply a greater supporting bottom and a better anchoring to the foundation also by holes/elongated holes useful for the fastening with anchor bolts, reinforcing ribs; holes for the grate's joint; preset internal winglets on the four corners to house a siphon. Square grate provided with: holes for the grate's joint; locking device made by elastic tongues that locks under the frame tongue and unlocks with a generic lever; parallel slots placed on two or more slots, pair of nuts and bolts properly housed in specific holes to allow the positioning of the grating in to the frame and prevent its theft and forcing; central concavity, where suitable, to carry out the minimum useful slope; anti-slipping patterns. All grates and frames must display: the reference standard, the loading class, the mark of the manufacturer in code and the date of the batch.

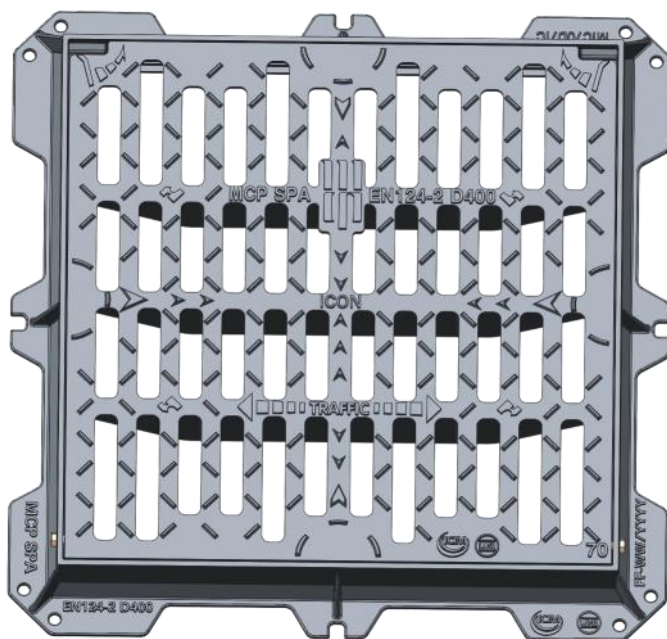
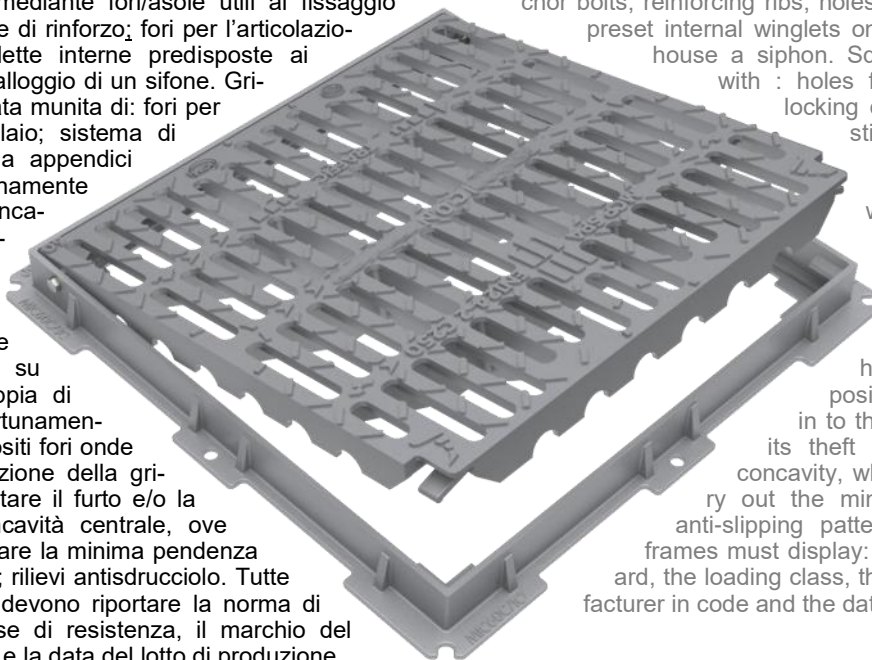

MIC60D/IC



MIC60C/IC



MICHELANGELO ICON PIANE



2025

CONFORME DPR 503/96 — COMPLY WITH DPR 503/96

CODICE CODE	CLASSE CLASS	DIMENSIONI ESTERNE EXTERNAL DIMENSIONS mm	LUCE NETTA CLEAR OPENING mm	ALTEZZA HEIGHT mm	SCARICO DRAINAGE dm ²	PESO TOTALE TOTAL WEIGHT Kg.	PEZZI PER PEDANA PIECES ON PALLET n.	SIFONE NON INCLUSO SIPHON NOT INCLUDED	NOTE NOTES	LISTINO PRICE LIST €
MIC30C/IC	C250	300X300	200X200	45	2,24	5,5	48	SIFPLAST20 SIF20	PIANA FLAT	52,00
MIC40C/IC	C250	400X400	300X300	45	3,85	11,5	48	SIFPLAST30 SIF30	PIANA FLAT	88,00
MIC50C/IC	C250	500X500	400X400	45	6,80	17	20	SIFPLAST40 SIF40	PIANA FLAT	135,00
MIC55C/IC	C250	550X550	450X450	45	9,00	23	20	SIFPLAST45 SIF45	PIANA FLAT	175,00
MIC60C/IC	C250	600X600	500X500	50	11,13	27	20	SIFPLAST50 SIF50	PIANA FLAT	215,00
MIC70C/IC	C250	700X700	600X600	50	15,84	36	16	SIFPLAST60 SIF60	PIANA FLAT	280,00
MIC80C/IC	C250	800X800	700X700	65	22,34	56,5	12		PIANA FLAT	451,00
MIC90C/IC	C250	900X900	800X800	75	27,51	76	10		PIANA FLAT	604,00
MIC40D/IC	ii D400	400X400	300X300	75	3,98	17,5	24	SIFPLAST30 SIF30	PIANA FLAT	160,00
MIC50D/IC	ii D400	500X500	350X350	80	5,07	24	20	SIFPLAST35	PIANA FLAT	i 186,00
MIC55D/IC	ii D400	550X550	400X400	80	7,54	28,5	20	SIFPLAST40 SIF40	PIANA FLAT	i 219,00
MIC60D/IC	ii D400	600X600	500X500	75	11,09	36	20	SIFPLAST50 SIF50	PIANA FLAT	266,00
MIC70D/IC	ii D400	700X700	550X550	80	12,38	48	12	SIFPLAST55	PIANA FLAT	i 371,00
MIC80D/IC	ii D400	800X800	700X700	80	21,75	66	10		PIANA FLAT	535,00
MIC90D/IC	ii D400	900X900	800X800	80	27,43	92	8		PIANA FLAT	734,00
MIC100D/IC	ii D400	1000X1000	900X900	80	34,71	116	8		PIANA FLAT	i 1.006,00

i - Non conforme al DPR 503/96
i - Not comply with DPR 503/96

ii - Chiusura automatica
ii - Auto locking



57

Caditoie in ghisa sferoidale
Ductile cast iron gully tops



MICHELANGELO ICON CONCAVE



CONFORME DPR 503/96 — COMPLY WITH DPR 503/96

CODICE CODE	CLASSE CLASS	DIMENSIONI ESTERNE EXTERNAL DIMENSIONS mm	LUCE NETTA CLEAR OPENING mm	ALTEZZA HEIGHT mm	SCARICO DRAINAGE dm ²	PESO TOTALE TOTAL WEIGHT Kg.	PEZZI PER PEDANA PIECES ON PALLET n.	SIFONE NON INCLUSO SIPHON NOT INCLUDED	NOTE NOTES	LISTINO PRICE LIST €
MIC40C/C/IC	C250	400X400	300X300	55	3,79	12	48	SIFPLAST30 SIF30	CONCAVITA' 15 mm 15 mm CONCAVITY	91,00
MIC50C/C/IC	C250	500X500	400X400	55	6,85	18,5	20	SIFPLAST40 SIF40	CONCAVITA' 15 mm 15 mm CONCAVITY	142,00
MIC55C/C/IC	C250	550X550	450X450	55	8,99	23,5	20	SIFPLAST45 SIF45	CONCAVITA' 15 mm 15 mm CONCAVITY	182,00
MIC60C/C/IC	C250	600X600	500X500	60	11,10	29,5	20	SIFPLAST50 SIF50	CONCAVITA' 15 mm 15 mm CONCAVITY	226,00
MIC70C/C/IC	C250	700X700	600X600	65	15,00	38	16	SIFPLAST60 SIF60	CONCAVITA' 15 mm 15 mm CONCAVITY	291,00
MIC50D/C/IC	ii D400	500X500	350X350	83	5,33	24,5	20	SIFPLAST35 SIF35	CONCAVITA' 8 mm 8 mm CONCAVITY	189,00
MIC60D/C/IC	ii D400	600X600	500X500	83	11,03	37	20	SIFPLAST50 SIF50	CONCAVITA' 8 mm 8 mm CONCAVITY	284,00
MIC70D/C/IC	ii D400	700X700	550X550	83	13,10	48,5	12	SIFPLAST55	CONCAVITA' 8 mm 8 mm CONCAVITY	371,00

i - Non conforme al DPR 503/96
i - Not comply with DPR 503/96

ii - Chiusura automatica
ii - Auto locking



Sifoni venduti separatamente.

Sifonatura opzionale delle caditoie con i sifoni in polipropilene o in ghisa indicati a pag. 61



Syphons sold separately.

Optional gully top syphoning, by means of syphons in polypropylene or cast iron as indicated on p. 61

Certificazioni
Certifications



2025

MICHELANGELO ICON F900

Apertura Assistita



Caditoie in ghisa sferoidale
Ductile cast iron gully tops



58



CARATTERISTICHE:

- ⇒ Carico di rottura > 900kN
Breaking load > 900kN
- ⇒ Apertura assistita con due molle a gas.
Opening assisted by two gas springs.
- ⇒ Identificazione dimensionale del prodotto.
Identification of the product size.

NEW PRODUCT

Certificazioni
Certifications

CODICE	CLASSE	DIMENSIONI ESTERNE	LUCE NETTA	ALTEZZA	SCARICO	PESO TOTALE	PEZZI PER PEDANA	SIFONE NON INCLUSO	NOTE	LISTINO
CODE	CLASS	EXTERNAL DIMENSIONS	CLEAR OPENING	HEIGHT	DRAINAGE	TOTAL WEIGHT	PIECES ON PALLET	SIPHON NOT INCLUDED	NOTES	PRICE LIST
		mm	mm	mm	dm ²	Kg.	n.			€
MIC105F/IC	F900	1050x1098	900X900	100	30,6	260	3			3.203,00



MICHELANGELO PIANE



2025

CONFORME DPR 503/96 — COMPLY WITH DPR 503/96

CODICE CODE	CLASSE CLASS	DIMENSIONI ESTERNE EXTERNAL DIMENSIONS mm	LUCE NETTA CLEAR OPENING mm	ALTEZZA HEIGHT mm	SCARICO DRAINAGE dm ²	PESO TOTALE TOTAL WEIGHT Kg.	PEZZI PER PEDANA PIECES ON PALLET n.	SIFONE NON INCLUSO SIPHON NOT INCLUDED	NOTE NOTES	LISTINO PRICE LIST €
MIC30C/SP	C250	300X300	200X200	45	2,19	6	48	SIFPLAST20 SIF20	PIANA FLAT	52,00
MIC40C/SP	C250	400X400	300X300	45	3,77	12	48	SIFPLAST30 SIF30	PIANA FLAT	88,00
MIC50C/SP	C250	500X500	400X400	45	6,74	18,5	20	SIFPLAST40 SIF40	PIANA FLAT	135,00
MIC55C/SP	C250	550X550	450X450	45	8,79	24	20	SIFPLAST45 SIF45	PIANA FLAT	175,00
MIC60C/SP	C250	600X600	500X500	50	10,95	29,5	20	SIFPLAST50 SIF50	PIANA FLAT	215,00
MIC70C/SP	C250	700X700	600X600	50	15,73	38,5	16	SIFPLAST60 SIF60	PIANA FLAT	280,00
MIC80C/SP	C250	800X800	700X700	65	22,09	59	12		PIANA FLAT	451,00
MIC90C/SP	C250	900X900	800X800	75	27,43	79	10		PIANA FLAT	604,00
MIC40D/SP	D400	400X400	300X300	75	3,98	18,5	24	SIFPLAST30 SIF30	PIANA FLAT	160,00
MIC50D/SP	D400	500X500	350X350	80	5,04	25,5	20	SIFPLAST35	PIANA FLAT	i 186,00
MIC55D/SP	D400	550X550	400X400	80	7,59	30	20	SIFPLAST40 SIF40	PIANA FLAT	i 219,00
MIC60D/SP	D400	600X600	500X500	75	11,03	36,5	20	SIFPLAST50 SIF50	PIANA FLAT	266,00
MIC70D/SP	D400	700X700	550X550	80	12,33	51	12	SIFPLAST55	PIANA FLAT	i 371,00
MIC80D/SP	D400	800X800	700X700	80	21,74	70	10		PIANA FLAT	535,00
MIC90D/SP	D400	900X900	800X800	80	27,43	96	8		PIANA FLAT	734,00
MIC100D/SP	D400	1000X1000	900X900	80	34,70	120	8		PIANA FLAT	i 1.006,00

i - Non conforme al DPR 503/96
i - Not comply with DPR 503/96

Caditoie in ghisa sferoidale
Ductile cast iron gully tops

59



MICHELANGELO CONCAVE



CONFORME DPR 503/96 — COMPLY WITH DPR 503/96

CODICE CODE	CLASSE CLASS	DIMENSIONI ESTERNE EXTERNAL DIMENSIONS mm	LUCE NETTA CLEAR OPENING mm	ALTEZZA HEIGHT mm	SCARICO DRAINAGE dm ²	PESO TOTALE TOTAL WEIGHT Kg.	PEZZI PER PEDANA PIECES ON PALLET n.	SIFONE NON INCLUSO SIPHON NOT INCLUDED	NOTE NOTES	LISTINO PRICE LIST €
MIC40C/C/SP	C250	400X400	300X300	55	3,66	12,5	48	SIFPLAST30 SIF30	CONCAVITA' 15 mm 15 mm CONCAVITY	91,00
MIC50C/C/SP	C250	500X500	400X400	55	6,73	19,5	20	SIFPLAST40 SIF40	CONCAVITA' 15 mm 15 mm CONCAVITY	142,00
MIC55C/C/SP	C250	550X550	450X450	55	8,79	25	20	SIFPLAST45 SIF45	CONCAVITA' 15 mm 15 mm CONCAVITY	182,00
MIC60C/C/SP	C250	600X600	500X500	60	10,80	31	20	SIFPLAST50 SIF50	CONCAVITA' 15 mm 15 mm CONCAVITY	226,00
MIC70C/C/SP	C250	700X700	600X600	65	15,36	40	16	SIFPLAST60 SIF60	CONCAVITA' 15 mm 15 mm CONCAVITY	291,00
MIC50D/C/SP	D400	500X500	350X350	83	5,33	26	20	SIFPLAST35 SIF35	CONCAVITA' 8 mm 8 mm CONCAVITY	189,00
MIC60D/C/SP	D400	600X600	500X500	83	11,03	39	20	SIFPLAST50 SIF50	CONCAVITA' 8 mm 8 mm CONCAVITY	284,00
MIC70D/C/SP	D400	700X700	550X550	83	13,10	51	12	SIFPLAST55	CONCAVITA' 8 mm 8 mm CONCAVITY	371,00

Sifoni venduti separatamente.

Sifonatura opzionale delle caditoie con i sifoni in polipropilene o in ghisa indicati a pag. 61



Syphons sold separately.

Optional gully top syphoning, by means of syphons in polypropylene or cast iron as indicated on p. 61

Certificazioni
Certifications



2025

Caditoie in ghisa sferoidale
Ductile cast iron gully tops

60

www.mcpticino.it
www.mcpspa.it

SIFONI

Il sifone è un accessorio per caditoie serie MICHELANGELO e PINTURICCHIO. La funzione che svolge è quella di impedire l'esalazione di formazioni gassose e la fuoriuscita di cattivi odori provenienti dal condotto di scarico sottostante il pozzetto e quella di costituire una barriera anti-ratto. Esso va posizionato appoggiandolo sulle alette interne del telaio. Il flusso delle acque che cade nella griglia della caditoia, riempie la vaschetta del sifone, fuoriuscendo dagli scarichi presenti. Si consiglia una manutenzione periodica del sifone (svuotamento da terriccio, foglie, detriti, etc.) per evitarne l'intasamento e quindi il non corretto funzionamento.

Operazione di manutenzione:

- 1 - Aprire la griglia.
- 2 - Svuotare il sifone dai detriti e dai corpi estranei.
- 3 - Pulire la sede di appoggio del sifone.
- 4 - Reinscrivere il sifone nella sua sede.
- 5 - Aggiungere acqua per ripristinare la funzionalità del sifone.
- 6 - Richiudere la griglia.

The siphon is an accessory for gully tops MICHELANGELO and PINTURICCHIO series. Its functions is to prevent the formation of gases and the escape of unpleasant odors coming from the drainage duct below the manhole and to constitute an anti-rat barrier. It shall be positioned inside the frame on the inner winglet. The flow of runoff coming from the outlet fills the tank of the siphon overflowing through the present drains. It is recommended a regular maintenance of the siphon recommend periodic maintenance of the siphon (emptying the dirt, leaves, debris, etc.) to prevent clogging and, therefore, any malfunction.

Maintenance:

- 1 - Open the grate.
- 2 - Empty the siphon of waste and foreign objects.
- 3 - Clean the connection site of the siphon.
- 4 - Re-insert the siphon in its proper position.
- 5 - Pass water to clean the functionality of the siphon.
- 6 - Re-close the grate.



ISTRUZIONI DI MONTAGGIO DEL SIFONE SIPHON INSTALLATION INSTRUCTIONS

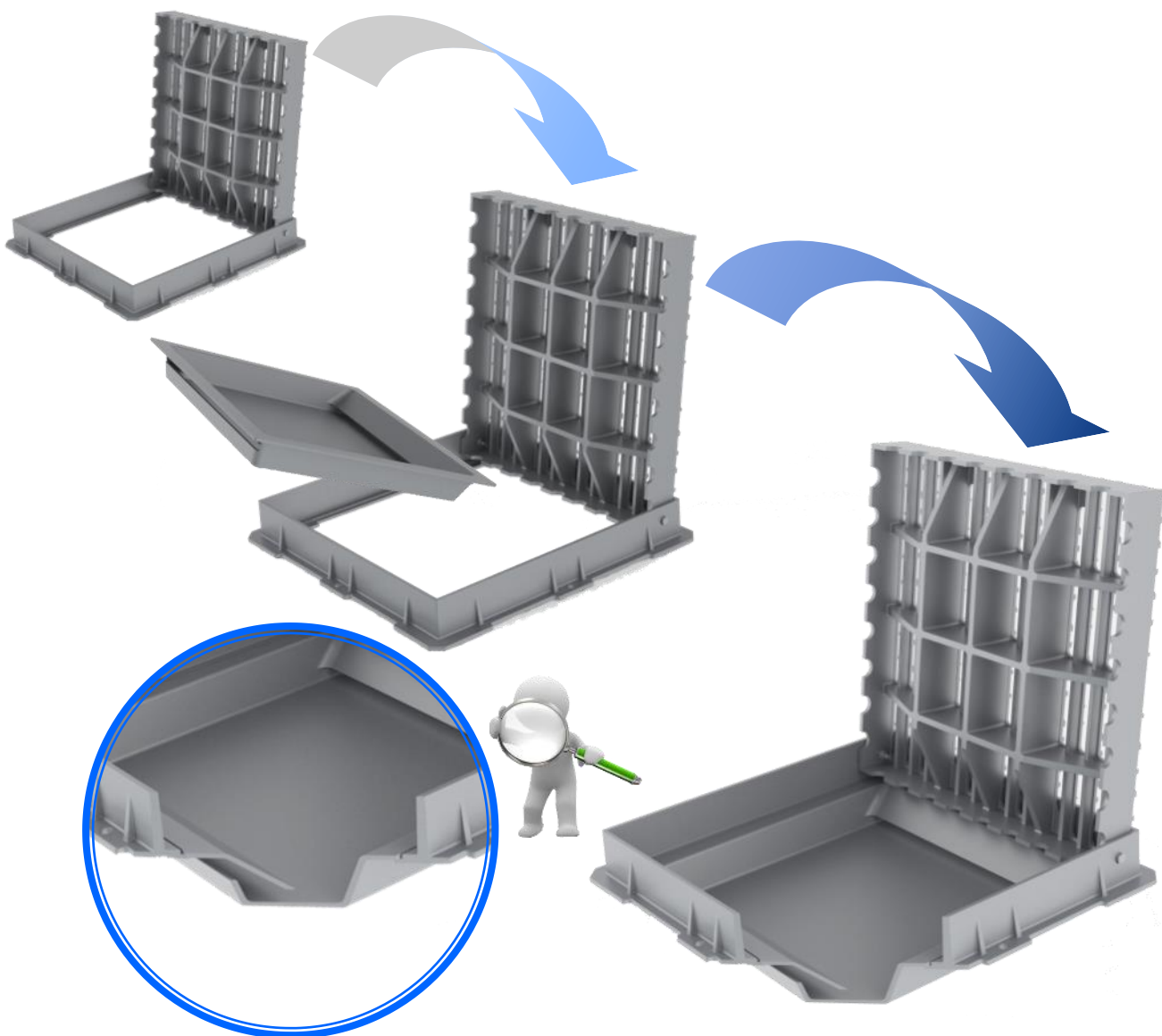



CODICE CODE	DIMENSIONI ESTERNE EXTERNAL DIMENSIONS mm	PER CADITOIE CON LUCE NETTA FOR GULLY TOP WITH CLEAR OPENING mm	ALTEZZA HEIGHT mm	PROFONDITA' DEPTH mm	PESO TOTALE TOTAL WEIGHT Kg.	NOTE NOTES	LISTINO PRICE LIST €
SIF20	200X200	200X200	58	53	2,5		31,00
SIF30	300X300	300X300	55	50	5		62,00
SIF40	402X402	400X400	60	55	8,5		105,00
SIF45	454X454	450X450	60	55	10,5		130,00
SIF50	498X498	500X500	60	55	12,5		154,00
SIF60	598X598	600X600	60	55	17,5		216,00

POLIPROPILENE

Il sifone in polipropilene di nuova concezione, progettato e realizzato dalla MCP SPA®, impedisce la risalita di cattivi odori ed esalazioni generate nella fogna sottostante evitando, contestualmente, la caduta di detriti nel pozzetto e agevolandone la manutenzione e la pulizia.

Il sifone è costituito da un recipiente con foro centrale delimitato da un bordo perimetrale e completato da una campana contrapposta al recipiente stesso. La campana presenta perimetralmente dei dentini che assolvono anche alla **funzione anti-ratto**. Il vantaggio principale risiede nell'**estrema efficacia e praticità** ma soprattutto nell'**altezza contenuta** del prodotto che ne permette l'uso in situazioni limite.

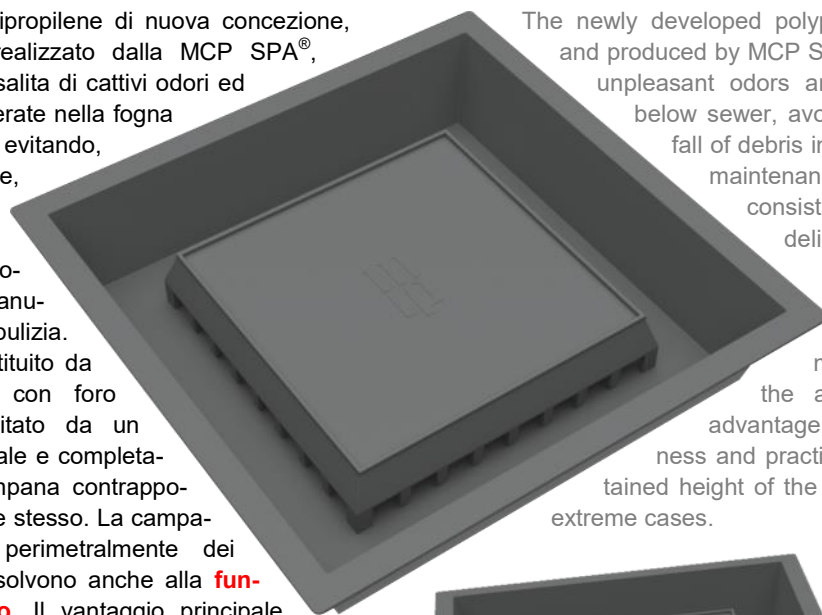

The newly developed polypropylene syphon, designed and produced by MCP SPA®, it prevents the return of unpleasant odors and fumes generated in the below sewer, avoiding, at the same time, the fall of debris in manhole and facilitating the maintenance and cleaning. The syphon consists of a tank with a central hole delimited by a perimetral edge and completed by a bell opposed to the tank. The bell presents teeth perimetrically that also perform the anti-rat function. The main advantage lies in the extreme effectiveness and practicality and mainly in the contained height of the product that can be used in extreme cases.

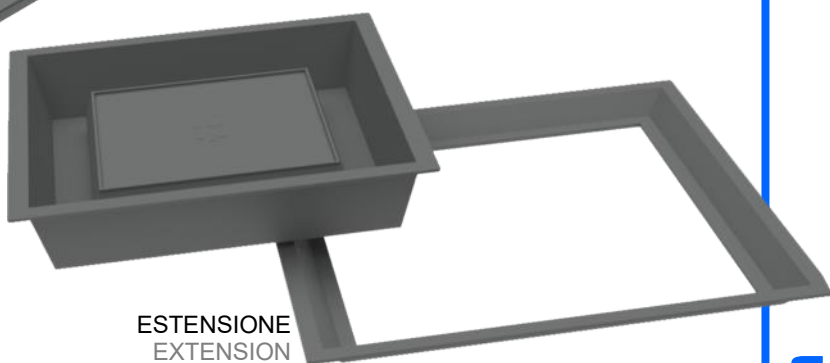

ESTENSIONE
EXTENSION

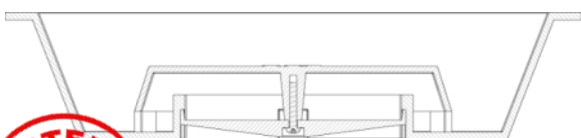

CODICE CODE	DIMENSIONI ESTERNE EXTERNAL DIMENSIONS mm	PER CADITOIE CON LUCE NETTA FOR GULLY TOP WITH CLEAR OPENING mm	ALTEZZA HEIGHT mm	PROFONDITA' DEPTH mm	PESO TOTALE TOTAL WEIGHT Kg.	PEZZI PER PACCO PIECES EACH BOXES n.	NOTE NOTES	LISTINO PRICE LIST €
SIFPLAST20	200X200	200X200	108	100	0,20	200		40,00
SIFPLAST30	300X300	300X300	95	90	0,85	7		61,00
SIFPLAST35	350X350	350X350	207	197	1	150		79,00
SIFPLAST40	400X400	400X400	95	90	1,6	6		90,00
SIFPLAST45	450X450	450X450	95	90	2	7		104,00
SIFPLAST50	500X500	500X500	95	90	2,3	7		119,00
SIFPLAST55	550X550	550X550	122	117	3	7	SIFPLAST50+ESTENSIONE SIFPLAST50+EXTENSION	135,00
SIFPLAST60	600X600	600X600	121	116	3,3	7	SIFPLAST50+ESTENSIONE SIFPLAST50+EXTENSION	155,00



2025

Caditoie in ghisa sferoidale
Ductile cast iron gully tops

62



Certificazioni
Certifications

PINTURICCHIO

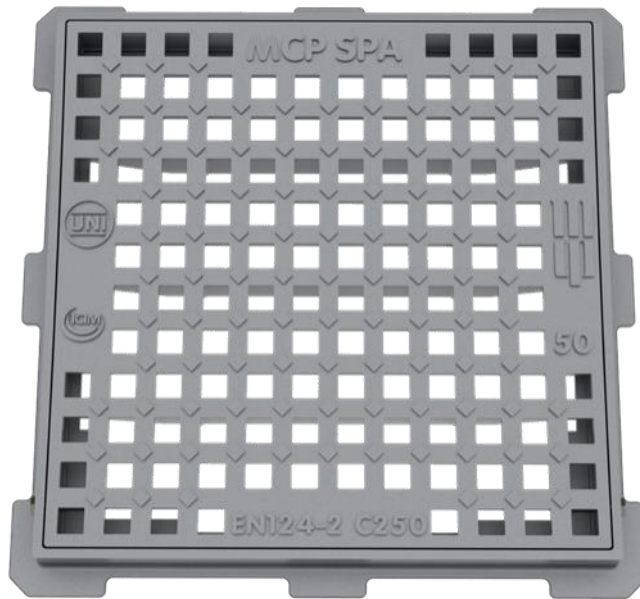

NIDO D'APE
HONEYCOMB



SIFONABILE
SIPHONABLE



BLOCCAGGIO
ANTIFURTO
ANTI-THEFT
SYSTEM

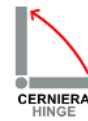

CERNIERA
HINGE



CLASSE
C 250

CARATTERISTICHE:

- ⇒ Carico di rottura > 250kN
Breaking load > 250kN
- ⇒ Telaio quadro con alette interne predisposte per l'alloggio di un sifone in polipropilene o ghisa. (vedi pag. 42)
Square frame with inner winglets set to house a polypropylene or cast iron siphon. (see p. 42)
- ⇒ Aletta perimetrale esterna, continua sui quattro lati del telaio per una maggiore base di appoggio e un migliore ancoraggio alla fondazione.
Continuous perimetric outer winglet, for a better anchorage to the foundation.
- ⇒ Griglia a nido d'ape con elevata capacità di scolo incernierata al telaio mediante bulloni.
High drainage capacity honeycomb grate, secured to the frame by bolts.
- ⇒ Identificazione dimensionale del prodotto.
Identification of the product size.

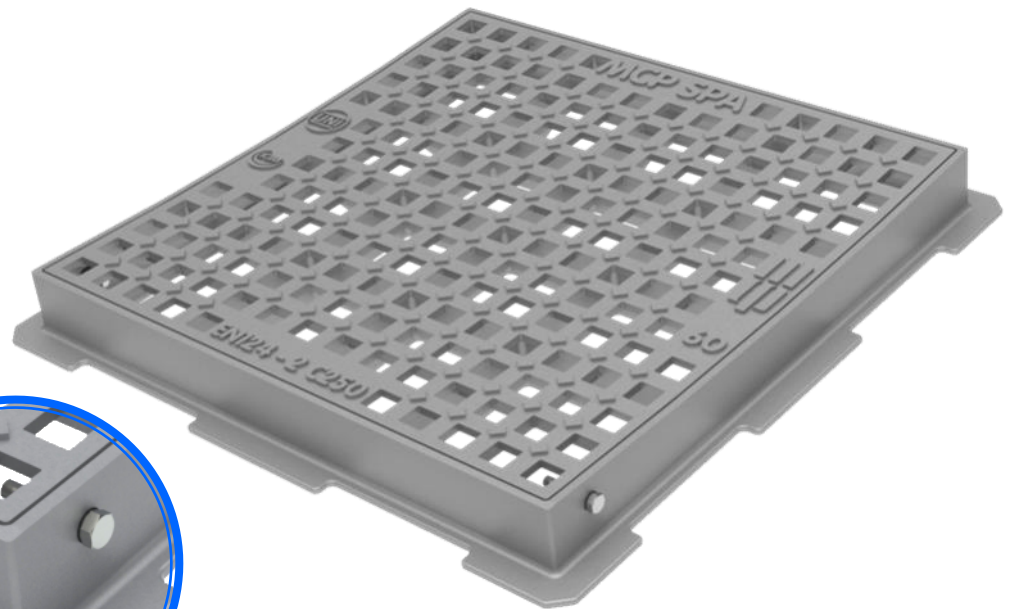

CODICE CODE	CLASSE CLASS	DIMENSIONI ESTERNE EXTERNAL DIMENSIONS mm	LUCE NETTA CLEAR OPENING mm	ALTEZZA HEIGHT mm	SCARICO DRAINAGE dm ²	PESO TOTALE TOTAL WEIGHT Kg.	PEZZI PER PEDANA PIECES ON PALLET n.	SIFONE NON INCLUSO SIPHON NOT INCLUDED	NOTE NOTES	LISTINO PRICE LIST €
PIN30C/C	C250	300X300	200X200	40	1,90	7,3	48		CONCAVITA' 4 mm 4 mm CONCAVITY	62,00
PIN40C/C	C250	400X400	300X300	45	3,01	14	48	SIFPLAST30 SIF30	CONCAVITA' 8 mm 8 mm CONCAVITY	102,00
PIN50C/C	C250	500X500	400X400	50	5,10	21	20	SIFPLAST40 SIF40	CONCAVITA' 8 mm 8 mm CONCAVITY	153,00
PIN60C/C	C250	600X600	500X500	60	8,71	33	20	SIFPLAST50 SIF50	CONCAVITA' 8 mm 8 mm CONCAVITY	240,00
PIN40C	C250	400X400	300X300	45	3,01	14	48	SIFPLAST30 SIF30	PIANA FLAT	102,00
PIN50C	C250	500X500	400X400	50	4,95	21	20	SIFPLAST40 SIF40	PIANA FLAT	153,00
PIN60C	C250	600X600	500X500	50	7,14	33	20	SIFPLAST50 SIF50	PIANA FLAT	240,00



PRODOTTO NON SIFONABILE
ITEM NOT SIPHONABLE

Sifoni venduti separatamente.

Sifonatura opzionale delle caditoie con i sifoni in polipropilene o in ghisa indicati a pag. 61



Syphons sold separately.

Optional gully top syphoning, by means of syphons in polypropylene or cast iron as indicated on p. 61



CARATTERISTICHE:

- ⇒ Carico di rottura > 250kN
Breaking load > 250kN
- ⇒ Telaio quadro con alette interne predisposte per l'alloggio di un sifone in ghisa.
Square frame with inner winglets set to house a polypropylene or cast iron siphon.
- ⇒ Griglia con elevata capacità di scolo.
High drainage capacity grate.
- ⇒ Ideale per zone ad alta frequenza di precipitazione meteoriche.
Ideal for areas with a high frequency of meteoric precipitation.



CAPACITA' DI SCARICO
DRAINAGE CAPACITY

GIORGIONE



2025

Caditoie in ghisa sferoidale
Ductile cast iron gully tops

CODICE	CLASSE	DIMENSIONI ESTERNE	LUCE NETTA	ALTEZZA	SCARICO	PESO TOTALE	PEZZI PER PEDANA	NOTE	LISTINO
CODE	CLASS	EXTERNAL DIMENSIONS	CLEAR OPENING	HEIGHT	DRAINAGE	TOTAL WEIGHT	PIECES ON PALLET	NOTES	PRICE LIST
		mm	mm	mm	dm ²	Kg.	n.		€
GSSC60GN/SF	C250	564X564	488X488	50	9,10	35	30	PIANA FLAT	121,00



SIFONATA
SIPHON

GHISA LAMELLARE GREY CAST IRON

CARATTERISTICHE:

- ⇒ Telaio quadro a campana con predisposizione per tubo di innesto.
Square frame and bell shaped body set up for coupling pipe.
- ⇒ Sifonatura.
Siphoning.
- ⇒ Ideale per giardini ed aree residenziali pedonali.
Ideal for gardens and residential pedestrian areas.
- ⇒ Identificazione dimensionale del prodotto.
Identification of the product size.
- ⇒ Telai singoli per il montaggio su pozzetto senza l'innesto in canalizzazione. (es. TIC30/ES + TIC30)
Single frame for installation on the manhole without direct plug-in with pipe. (ex. TIC30/ES + TIC30)

TICINO



63

CODICE		DIMENSIONI ESTERNE	LUCE NETTA	ALTEZZA	SCARICO	PESO TOTALE	PEZZI PER PEDANA	DIAMETRO DEL TUBO DI INNESTO	NOTE	LISTINO
CODE		EXTERNAL DIMENSIONS	CLEAR OPENING	HEIGHT	DRAINAGE	TOTAL WEIGHT	PIECES ON PALLET	DIAMETER OF COUPLIN PIPE	NOTES	PRICE LIST
		mm	mm	mm	dm ²	Kg.	n.	mm		€
TIC20	i	200X200	Ø 50	75	0,25	3,2	72	Ø 60		45,00
TIC25	i	250X250	Ø 80	95	0,45	5,5	72	Ø 90		68,00
TIC30	i	300X300	Ø 80	116	1,01	10	36	Ø 100		124,00
TIC40	i	400X400	Ø 96	158	1,17	25	24	Ø 125		308,00
TIC30/ES	ii	380X380	280X280	19		5			SOLO TELAIO FRAME SUITABLE	74,00
TIC40/ES	iii	500X500	380X380	22		8			SOLO TELAIO FRAME SUITABLE	119,00



i - Non prevista dalla norma EN124
i - Not included in EN124 standard

ii - Telaio singolo idoneo per caditoia TIC30
ii - Frame suitable for gully top TIC30

iii - Telaio singolo idoneo per caditoia TIC40
iii - Frame suitable for gully top TIC40

www.mcpomicino.com
www.mcpspa.com



2025

Caditoie in ghisa sferoidale
Ductile cast iron gully tops

INTERPORTO

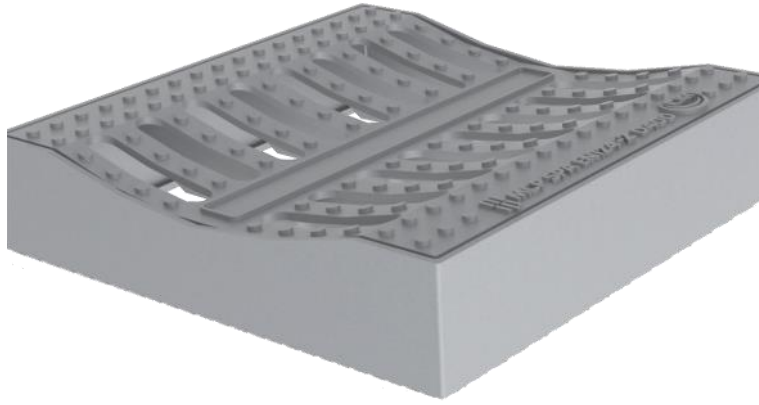

CARATTERISTICHE:

- ⇒ Carico di rottura > 250kN per la classe **C250**
> 400kN per la classe **D400**
Breaking load > 250kN for class **C250**
> 400kN for class **D400**
- ⇒ Ideale per zanelle e aree di sosta.
Ideal for gutter and parking areas.
- ⇒ Telaio quadro senza aletta perimetrale esterna.
Square frame without perimetric outer winglet.
- ⇒ Griglia con elevata capacità di scolo.
High drainage capacity grate.
- ⇒ Identificazione dimensionale del prodotto.
Identification of the product size.
- ⇒ Spazio per eventuale personalizzazione.
Space for an eventual personalization.

CODICE CODE	CLASSE CLASS	DIMENSIONI ESTERNE EXTERNAL DIMENSIONS mm	LUCE NETTA CLEAR OPENING mm	ALTEZZA HEIGHT mm	SCARICO DRAINAGE dm ²	PESO TOTALE TOTAL WEIGHT Kg.	PEZZI PER PEDANA PIECES ON PALLET n.	NOTE NOTES	LISTINO PRICE LIST €
INT50D	D400	500X500	450X450	106	6,40	43	24	CONCAVITA' 30 mm 30 mm CONCAVITY	424,00

64

PAVE' caditoia

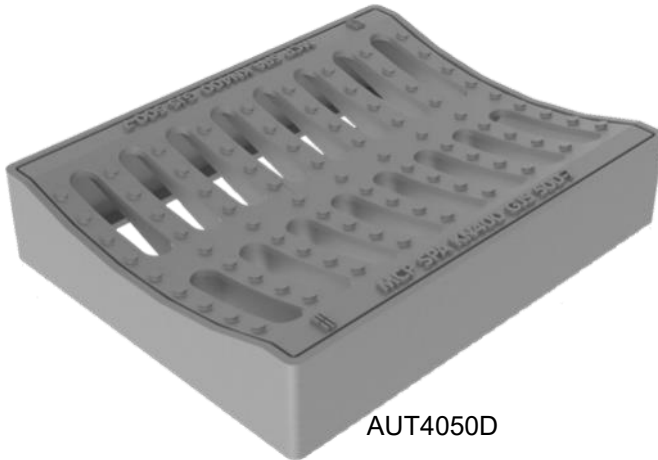

AUT4050D

CARATTERISTICHE:

- ⇒ Carico di rottura > 250kN
Breaking load > 250kN
- ⇒ Ideale per zanelle e aree di sosta.
Ideal for gutter and parking areas.

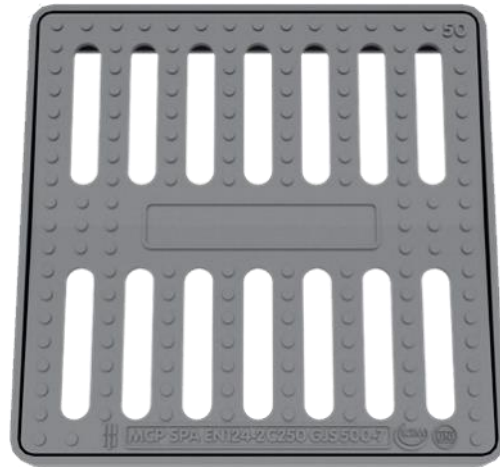

- ⇒ Telaio quadro senza aletta perimetrale esterna.
Square frame without perimetric outer winglet.
- ⇒ Griglia con elevata capacità di scolo.
High drainage capacity grate.
- ⇒ Identificazione dimensionale del prodotto.
Identification of the product size.
- ⇒ Spazio per eventuale personalizzazione.
Space for an eventual personalization.

CODICE CODE	CLASSE CLASS	DIMENSIONI ESTERNE EXTERNAL DIMENSIONS mm	LUCE NETTA CLEAR OPENING mm	ALTEZZA HEIGHT mm	SCARICO DRAINAGE dm ²	PESO TOTALE TOTAL WEIGHT Kg.	PEZZI PER PEDANA PIECES ON PALLET n.	NOTE NOTES	LISTINO PRICE LIST €
GSQC45/AU	C250	450X450	400X400	80	6,00	29	16	CONCAVITA' 8 mm 8 mm CONCAVITY	286,00
GSQC50/AU	C250	500X500	450X450	80	6,00	36	20	CONCAVITA' 8 mm 8 mm CONCAVITY	355,00
AUT4050D	KN400	400X500	330X430	100	5,89	37	20	CONCAVITA' 30 mm 30 mm CONCAVITY	365,00

NON PREVISTA DALLA NORMA EN124
NOT INCLUDED IN EN124 STANDARD

Certificazioni
Certifications





TIEPOLO



2025

CARATTERISTICHE:

- ⇒ Carico di rottura > 250kN per la classe **C250**
> 400kN per la classe **D400**
Breaking load > 250kN for class **C250**
> 400kN for class **D400**
- ⇒ Griglia con elevata capacità di scolo incernierata al telaio mediante bulloni.
High drainage capacity grate, secured to frame by bolts.
- ⇒ Telaio con aletta perimetrale esterna continua con asole e/o fori per una maggiore base di appoggio e un migliore ancoraggio alla fondazione.
Frame with a continuous outer winglet with elongated holes and or holes for a greater supporting base and a better anchorage to the foundation.
- ⇒ Identificazione dimensionale del prodotto.
Identification of the product size.

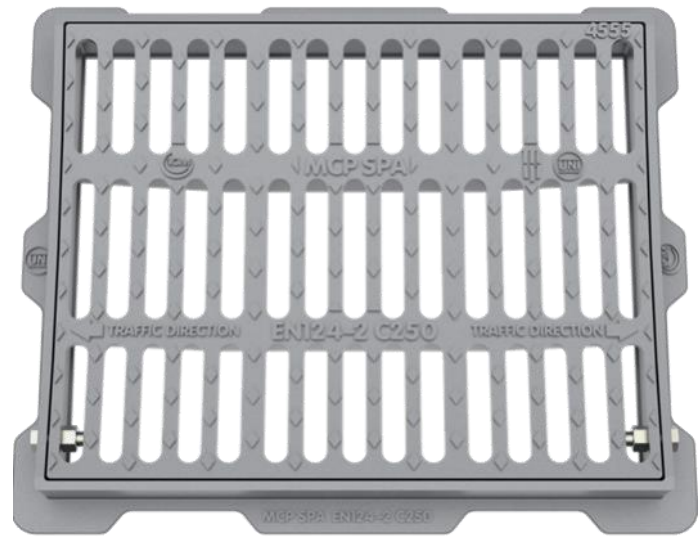

CODICE CODE	CLASSE CLASS	DIMENSIONI ESTERNE EXTERNAL DIMENSIONS mm	LUCE NETTA CLEAR OPENING mm	ALTEZZA HEIGHT mm	SCARICO DRAINAGE dm ²	PESO TOTALE TOTAL WEIGHT Kg.	PEZZI PER PEDANA PIECES ON PALLET n.	NOTE NOTES	LISTINO PRICE LIST €
TIE4555C/C	C250	450X550	350X450	60	7,84	21	52	CONCAVITA' 15 mm 15 mm CONCAVITY	135,00
TIE4555D	D400	450X550	350X450	75	8,32	30	36	PIANA FLAT	193,00

Caditoie in ghisa sferoidale
Ductile cast iron gully tops

65



MANTEGNA



CARATTERISTICHE:

- ⇒ Carico di rottura > 250kN
Breaking load > 250kN
- ⇒ Telaio con aletta perimetrale esterna continua per una maggiore base di appoggio e un migliore ancoraggio alla fondazione.
Frame with a continuous outer winglet for a greater supporting base and a better anchorage to the foundation.
- ⇒ Griglia con elevata capacità di scolo.
High drainage capacity grate.
- ⇒ Identificazione dimensionale del prodotto.
Identification of the product size.
- ⇒ Spazio per eventuale personalizzazione.
Space for an eventual personalization.



CODICE CODE	CLASSE CLASS	DIMENSIONI ESTERNE EXTERNAL DIMENSIONS mm	LUCE NETTA CLEAR OPENING mm	ALTEZZA HEIGHT mm	SCARICO DRAINAGE dm ²	PESO TOTALE TOTAL WEIGHT Kg.	PEZZI PER PEDANA PIECES ON PALLET n.	NOTE NOTES	LISTINO PRICE LIST €
MAN45C/C	C250	265X450	208X378	50	3,80	13	78	CONCAVITA' 5 mm 5 mm CONCAVITY	109,00
MAN52C/C	C250	320X520	255X440	50	4,70	19	52	CONCAVITA' 10 mm 10 mm CONCAVITY	150,00
MAN52C	C250	320X520	255X440	50	4,70	19	52	PIANA FLAT	150,00

Certificazioni
Certifications



2025

Caditoie in ghisa sferoidale
Ductile cast iron gully tops

MATISSE

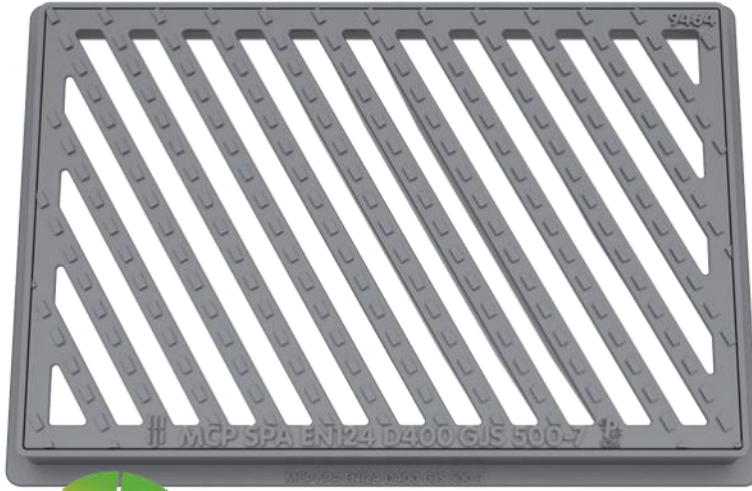

CARATTERISTICHE:

- ⇒ Carico di rottura > 400kN
Breaking load > 400kN
- ⇒ Telaio con aletta perimetrale esterna continua per una maggiore base di appoggio e un migliore ancoraggio alla fondazione.
Frame with a continuous outer winglet for a greater supporting base and a better anchorage to the foundation.
- ⇒ Griglia con elevata capacità di scolo.
High drainage capacity grate.
- ⇒ Identificazioni dimensionale del prodotto.
Identification of the product size.

CODICE	CLASSE	DIMENSIONI ESTERNE	LUCE NETTA	ALTEZZA	SCARICO	PESO TOTALE	PEZZI PER PEDANA	NOTE	LISTINO
CODE	CLASS	EXTERNAL DIMENSIONS	CLEAR OPENING	HEIGHT	DRAINAGE	TOTAL WEIGHT	PIECES ON PALLET	NOTES	PRICE LIST
		mm	mm	mm	dm ²	Kg.	n.		€
MAT6494D	D400	640X940	544X844	80	20,57	72	10	PIANA FLAT	639,00

66

RAFFAELLO caditoia



CARATTERISTICHE:

- ⇒ Carico di rottura > 900kN
Breaking load > 900kN
- ⇒ Telaio con aletta perimetrale esterna, continua sui quattro lati con asole e/o fori per una maggiore base di appoggio e un migliore ancoraggio alla fondazione.
Frame with a continuous outer winglet on the four sides with elongated holes and or holes for a greater supporting base and a better anchorage to the foundation.
- ⇒ Guarnizione in elastomero incassata nel telaio che garantisce silenziosità e stabilità.
Elastomeric cushioning insert fitted into the frame to guarantee silence and stability.
- ⇒ Griglia circolare a nido d'ape ad elevata capacità di scolo provvista di chiave e cerniera.
Circular honeycomb grating with high drainage capacity provided with locking system and hinge.
- ⇒ Blocco della Griglia a 90°.
Safety grate stop at 90°.
- ⇒ Identificazione dimensionale del prodotto.
Identification of the product size.

CODICE	CLASSE	DIMENSIONI ESTERNE	LUCE NETTA	ALTEZZA	SCARICO	PESO TOTALE	PEZZI PER PEDANA	NOTE	LISTINO
CODE	CLASS	EXTERNAL DIMENSIONS	CLEAR OPENING	HEIGHT	DRAINAGE	TOTAL WEIGHT	PIECES ON PALLET	NOTES	PRICE LIST
		mm	mm	mm	dm ²	Kg.	n.		€
RAF85F/G	F900	850X850	Ø 600	100	8,80	92	10	PIANA FLAT	816,00

Certificazioni
Certifications





Caditoia piana in ghisa sferoidale GJS-500-7 - EN 1563 prodotto, secondo quanto sancito dall'ultima edizione delle norme UNI EN 124, da azienda certificata ISO 9001:2015, costituito da telaio di forma quadrata/ottagonale/circolare, alla base di appoggio e circolare alla sommità corrispondente al livello del piano stradale, munito di: adeguata aletta perimetrale esterna continua sui lati, arrotondata agli angoli per ottenere una maggiore base di appoggio e consentire un migliore ancoraggio alla fondazione anche tramite apposite asole e/o fori sul perimetro; battuta interna sagomata; guarnizione in elastomero antirumore ed antibasculamento opportunamente sagomata ed incasata in apposita gola per contrastare frontalmente il bordo del coperchio ed assorbire anche le vibrazioni; vano cerniera a fondo chiuso con sistema di bloccaggio della griglia in posizione di apertura; appendice opportunamente sagomata sulla parete interna per il blocco del sistema di chiusura del coperchio. Griglia di forma circolare munita di: asole a nido d'ape distribuite in cerchi concentrici sull'intera superficie; appendice idonea a garantire l'articolazione della griglia al telaio nel vano cerniera senza impedirne la sua estraibilità; asola a fondo chiuso idonea ad accogliere una qualsiasi leva per l'apertura della griglia con il minimo sforzo; sistema di chiusura automatico realizzato mediante linguetta basculante, opportunamente sagomata, bullonata alla griglia con molla elicoidale di contrasto sollecitata a compressione; particolare identificativo delle dimensioni e della forma esterna del telaio espresse in cm; rilievi antisdrucchiolo. Tutte le griglie ed i telai devono riportare la norma di riferimento, la classe di resistenza, il marchio del produttore in codice e la data del lotto di produzione.

Ductile cast iron GJS/500/7 - EN 1563 flat gully top produced, according to the provisions of UNI EN 124 latest edition, by ISO 9001:2015 certified company, consisting of a square/round/octagonal frame as supporting base and a round grate at the top corresponding to the street level, provided with: outer continuous winglet with round corners along the four sides, in order to obtain a greater supporting base and a better anchoring to the foundation also by elongated holes and/or holes on the perimeter; internal shaped seat; anti-noise and anti-rocking elastomer cushioning insert, suitably shaped and encased in its housing to frontally withstand the edge of the cover and absorb vibrations; hinge housing with closed bottom and grate locking system in open position; suitably shaped appendix on the inner part for blocking the closing system of the cover. Round grate provided with: honeycomb shaped slots placed in concentric circles all over the walking surface; an appendix suitable to ensure the positioning of the grate to the frame in the hinge compartment without preventing the extractability of the grate; buttonhole with closed bottom suitable for accommodating any lever for the opening of the cover with the minimum effort; automatic closing system realized by a pivoting tab, suitably shaped, bolted to the grate with a contrast helical spring stressed by compression; identification of the outer shape of the frame and of the product size, expressed in cms.; anti-slippery reliefs; All grates and frames must display: the reference standard, the loading class, the mark of the manufacturer in code and the date of the batch.

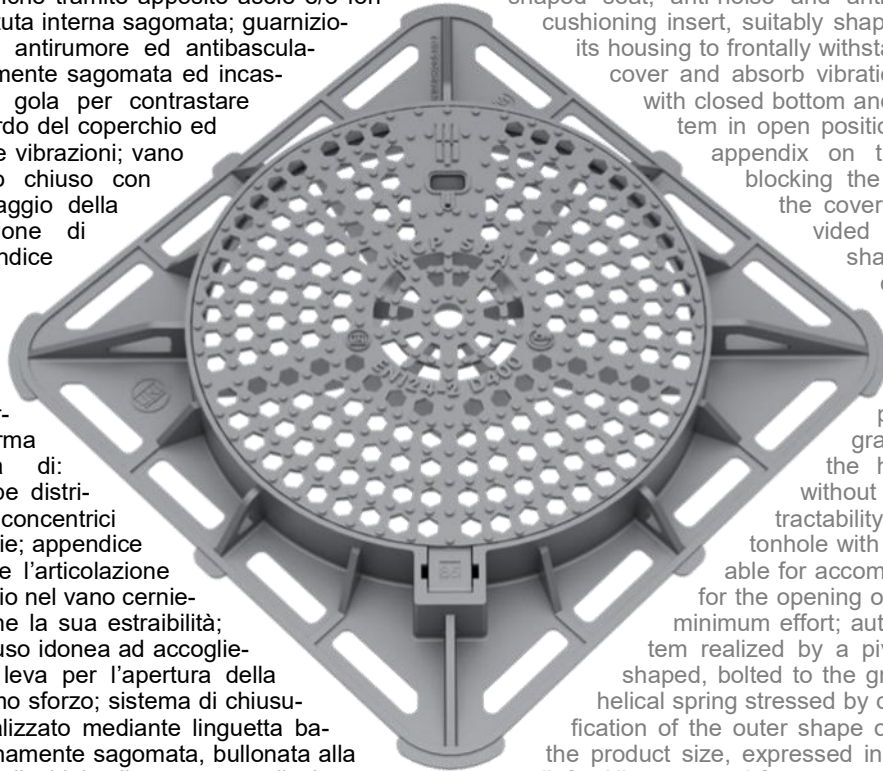

DEC85D

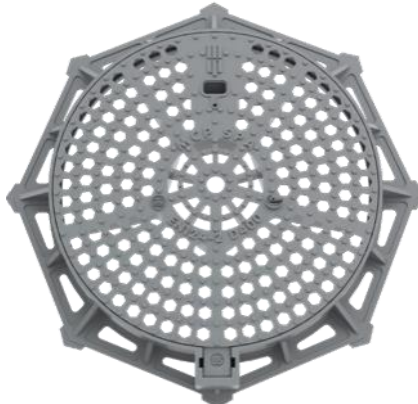

DEC85D/T



DEC85D/C

CODICE CODE	CLASSE CLASS	DIMENSIONI ESTERNE EXTERNAL DIMENSIONS	LUCE NETTA CLEAR OPENING	ALTEZZA HEIGHT	SCARICO DRAINAGE	PESO TOTALE TOTAL WEIGHT	PEZZI PER PEDANA PIECES ON PALLET	NOTE NOTES	LISTINO PRICE LIST
		mm	mm	mm	dm²	Kg.	n.		€
DEC75D	D400	750X750	Ø 610	100	9,00	57	10	PIANA TELAIO QUADRATO FLAT SQUARE FRAME	478,00
DEC85D	D400	850X850	Ø 610	100	9,00	63	10	PIANA TELAIO QUADRATO FLAT SQUARE FRAME	528,00
DEC85D/T	D400	Ø 850	Ø 610	100	9,00	54	10	PIANA TELAIO OTTAGONALE FLAT OCTAGONAL FRAME	466,00
DEC85D/C	D400	Ø 850	Ø 610	100	9,00	57	10	PIANA TELAIO CIRCOLARE FLAT ROUND FRAME	492,00





2025

Caditoie in ghisa sferoidale
Ductile cast iron gully tops

LIGABUE

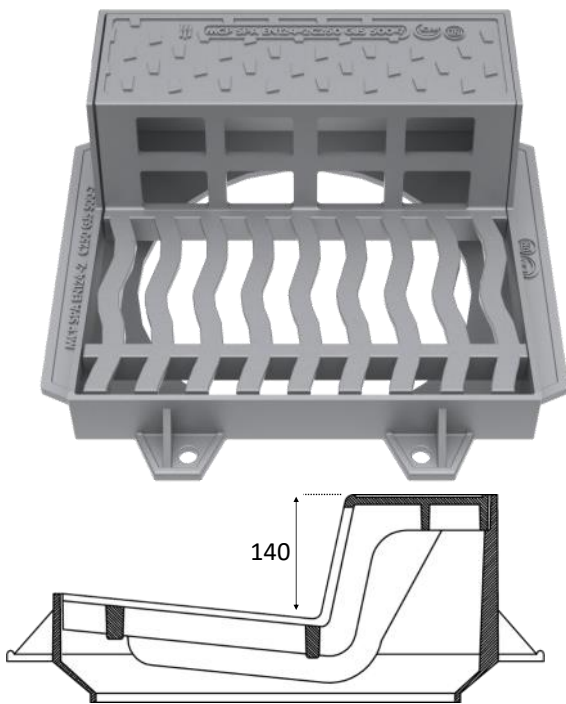

CARATTERISTICHE:

- ⇒ Carico di rottura > 250kN
Breaking load > 250kN
- ⇒ Telaio con aletta perimetrale esterna con asole e/o fori per una maggiore base di appoggio e un migliore ancoraggio alla fondazione.
Frame with a continuous outer winglet with elongated holes and or holes for a greater supporting base and a better anchorage to the foundation.
- ⇒ Ideale per cordoli di marciapiede.
Ideal for kerbs.
- ⇒ Griglia completamente estraibile.
Removable grate.
- ⇒ Griglia frontale con barre selettive per impedire l'ingresso di corpi estranei nel pozzetto.
Frontal grate with bars to inhibit foreign objects from entering into the manhole.
- ⇒ Spazio per eventuale personalizzazione.
Space for an eventual personalization.

CODICE	CLASSE	DIMENSIONI ESTERNE	LUCE NETTA	ALTEZZA	SCARICO	PESO TOTALE	PEZZI PER PEDANA	NOTE	LISTINO
CODE	CLASS	EXTERNAL DIMENSIONS	CLEAR OPENING	HEIGHT	DRAINAGE	TOTAL WEIGHT	PIECES ON PALLET	NOTES	PRICE LIST
		mm	mm	mm	dm ²	Kg.	n.		€
LIG60C/G	C250	562X605	Ø 405	233	9,00	62	16		677,00

68

LIGABUE



CARATTERISTICHE:

- ⇒ Carico di rottura > 125kN per la classe **B125**
> 250kN per la classe **C250**
Breaking load > 125kN for class **B125**
> 250kN for class **C250**
- ⇒ Ideale per cordoli di marciapiede.
Ideal for kerbs.
- ⇒ Spazio per eventuale personalizzazione.
Space for an eventual personalization.



CODICE	CLASSE	DIMENSIONI ESTERNE	LUCE NETTA	ALTEZZA	SCARICO	PESO TOTALE	PEZZI PER PEDANA	NOTE	LISTINO
CODE	CLASS	EXTERNAL DIMENSIONS	CLEAR OPENING	HEIGHT	DRAINAGE	TOTAL WEIGHT	PIECES ON PALLET	NOTES	PRICE LIST
		mm	mm	mm	dm ²	Kg.	n.		€
LIG6061C	C250	600X610	Ø 465	180	5,60	48	8		524,00
LIG80BC	B125	800X830	Ø 610	200	8,74	66	8		721,00



Certificazioni
Certifications



LIGABUE



2025

CARATTERISTICHE:

- ⇒ Carico di rottura > 250kN
Breaking load > 250kN
- ⇒ Ideale per cordoli di marciapiede.
Ideal for kerbs.
- ⇒ Coperchio bullonato al telaio.
Cover bolted to the frame.
- ⇒ Spazio per eventuale personalizzazione.
Space for an eventual personalization.

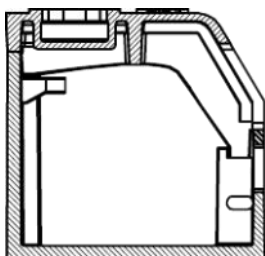
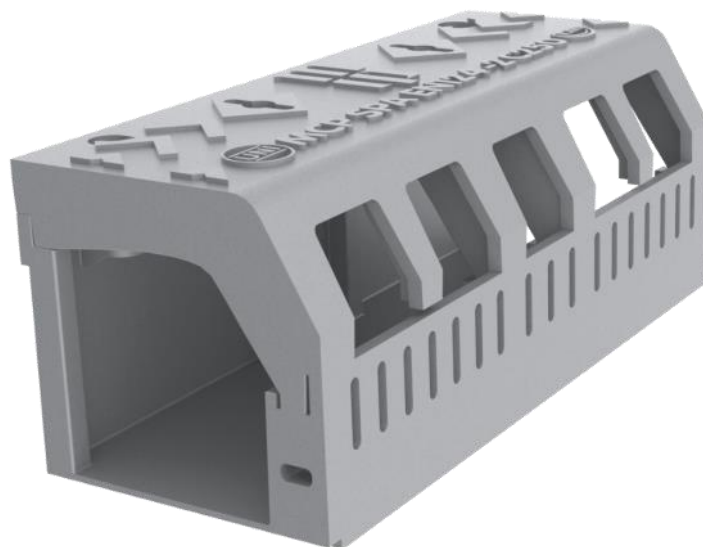

CODICE	CLASSE	DIMENSIONI ESTERNE	LUCE NETTA	ALTEZZA	SCARICO	PESO TOTALE	PEZZI PER PEDANA	NOTE	LISTINO
CODE	CLASS	EXTERNAL DIMENSIONS	CLEAR OPENING	HEIGHT	DRAINAGE	TOTAL WEIGHT	PIECES ON PALLET	NOTES	PRICE LIST
		mm	mm	mm	dm ²	Kg.	n.		€
LIG2050C	C250	200X500		190	2,13	27	30		295,00

Caditoie in ghisa sferoidale
Ductile cast iron gully tops

LIGABUE

69

CARATTERISTICHE:

- ⇒ Carico di rottura > 250kN
Breaking load > 250kN
- ⇒ Ideale per cordoli di marciapiede.
Ideal for kerbs.
- ⇒ Spazio per eventuale personalizzazione.
Space for an eventual personalization.

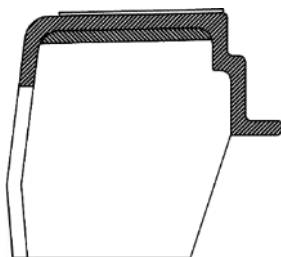
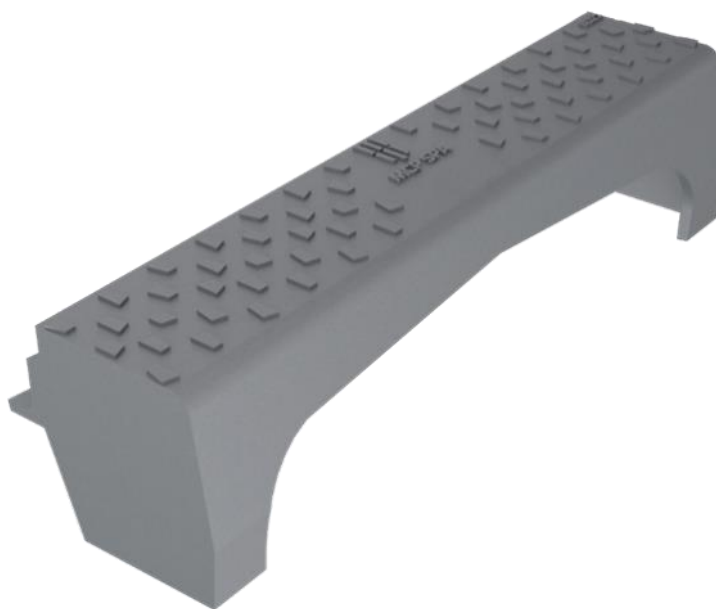

CODICE	CLASSE	DIMENSIONI ESTERNE	LUCE NETTA	ALTEZZA	SCARICO	PESO TOTALE	PEZZI PER PEDANA	NOTE	LISTINO
CODE	CLASS	EXTERNAL DIMENSIONS	CLEAR OPENING	HEIGHT	DRAINAGE	TOTAL WEIGHT	PIECES ON PALLET	NOTES	PRICE LIST
		mm	mm	mm	dm ²	Kg.	n.		€
LIG2280C	KN250	225X800		200	8,17	28	30		306,00



NON PREVISTA DALLA NORMA EN124
NOT INCLUDED IN EN124 STANDARD



Certificazioni
Certifications



2025

Caditoie in ghisa sferoidale
Ductile cast iron gully tops

70



Certificazioni
Certifications

CEZANNE

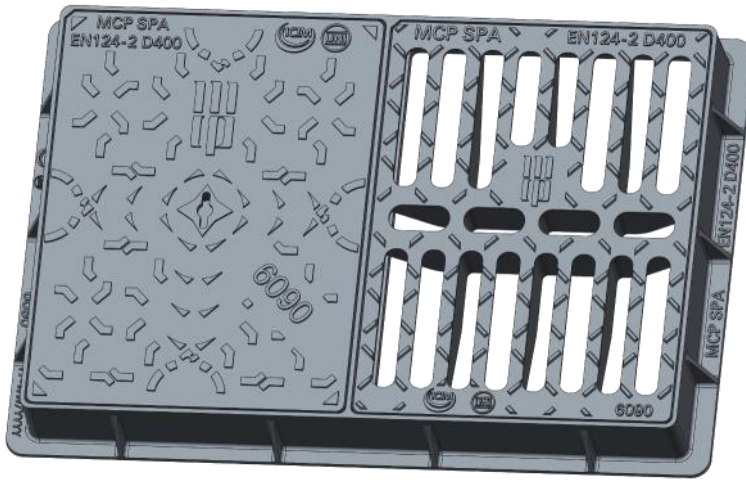

CEZ6090D/CG

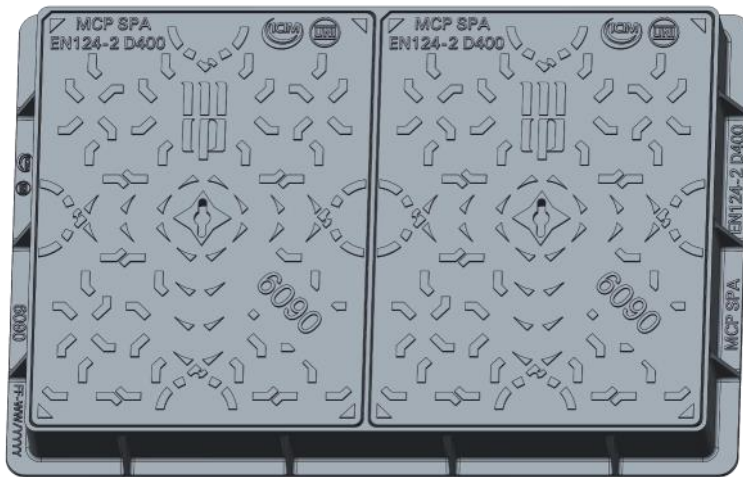

CEZ6090D/CC

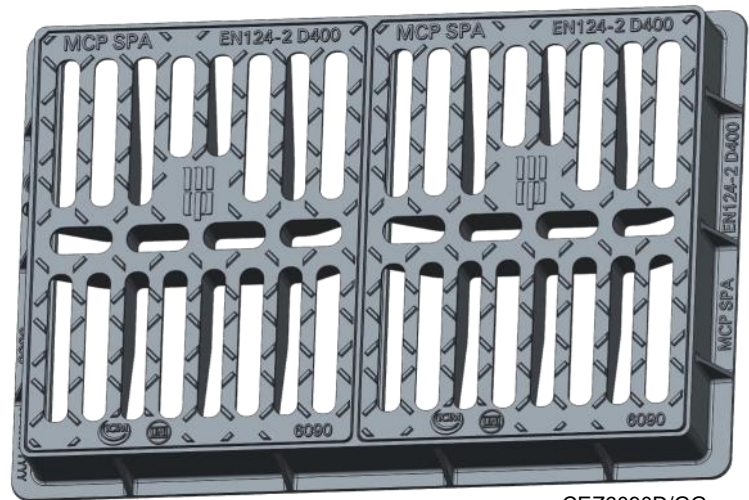

CEZ6090D/GG



CODICE CODE	CLASSE CLASS	DIMENSIONI ESTERNE EXTERNAL DIMENSIONS mm	LUCE NETTA CLEAR OPENING mm	ALTEZZA HEIGHT mm	SCARICO DRAINAGE dm ²	PESO TOTALE TOTAL WEIGHT Kg.	PEZZI PER PEDANA PIECES ON PALLET n.	NOTE NOTES	LISTINO PRICE LIST €
CEZ6090D/CC	D400	600X900	370X500	100		78	10	2 COPERCHI 2 COVERS	692,00
CEZ6090D/CG	D400	600X900	370X500	100	6,95	83	10	COPERCHIO + GRIGLIA COVER + GRATE	737,00
CEZ6090D/GG	D400	600X900	370X500	100	13,90	88	10	2 GRIGLIE 2 GRATES	781,00
CEZ6090D/IC/CC	D400	600X900	370X495	100		76	10	2 COPERCHI 2 COVERS	675,00
CEZ6090D/IC/CG	D400	600X900	370X495	100	10,07	78	10	COPERCHIO + GRIGLIA COVER + GRATE	692,00
CEZ6090D/IC/GG	D400	600X900	370X495	100	20,14	80	10	2 GRIGLIE 2 GRATES	710,00

CARATTERISTICHE:

- ⇒ Carico di rottura > 400kN
Breaking load > 400kN
- ⇒ Telaio con aletta perimetrale esterna, continua sui quattro lati, con asole e/o fori per una maggiore base di appoggio e un migliore ancoraggio alla fondazione.
Frame with a continuous outer winglet on the four sides with elongated holes and or holes for a greater supporting base and a better anchorage to the foundation.
- ⇒ Griglia/e, nelle versioni a caditoie, con elevata e capacità di scolo.
Grate/s, where expected, with high drainage capacity.
- ⇒ Identificazione dimensionale del prodotto.
Identification of the product size.
- ⇒ Spazio per eventuale personalizzazione.
Space for an eventual personalization.

NUOVI PERCORSI SONO POSSIBILI.
NEW PATHS ARE POSSIBLE.



GRIGLIE E CANALETTE 

GRATES AND CHANNELS 

GRELLES ET LE CANAL 

GREDS UND KANAL 

REJAS Y CANALES 

Designed by MCP SPA® in Italy



2025

Griglie e Canalette
Grates and Channels

72



Certificazioni
Certifications

UTRILLO

Griglia in ghisa sferoidale GJS-500-7 – EN 1563 prodotta, secondo le prescrizioni sancite dall'ultima edizione in vigore delle norme UNI EN 124, da azienda certificata ISO 9001:2015, costituita da longheroni muniti di: adeguata aletta perimetrale, opportunamente asolata, per consentire un migliore ancoraggio alla fondazione, fori filettati per bloccare la griglia mediante bulloni. Griglia di forma rettangolare munita di: asole parallele disposte su una o più file; asole sui lati lunghi per il bloccaggio delle griglie ai longheroni mediante bulloni con testa esagonale; appendici sul lato minore per l'alloggio in apposita sede della griglia adiacente; sede opportunamente sagomata per consentire l'alloggio delle appendici della griglia adiacente; rilievi antisdrucchiolo. Tutte le griglie ed i longheroni devono riportare il marchio di un ente di certificazione terzo, la sigla EN 124, la classe di resistenza, il marchio del produttore in codice e la data del lotto di produzione.

Ductile cast iron GJS-500-7 - EN 1563 grating produced, according to the provisions of UNI EN 124 latest edition, by ISO 9001:2015 certified company, consisting of lateral bars provided with: specific outer winglet, properly pierced in order to allow a better anchoring to the foundation; internal shaped seating; treaded holes to secure the grate by bolts. Rectangular grate provided with: parallel slots placed in one or more rows; holes onto the longer sides for securing the grates to lateral bars by hexagonal head bolts; spline on the shorter side for the insertion of the adjacent grate in the opposite proper seating; properly shaped seating to allow the securing of the spline; anti-slipping patterns. All grates and lateral bars must display the logo of a third-party certification body, the inscription "EN 124", the loading class, the mark of the manufacturer in code and the date of the batch.

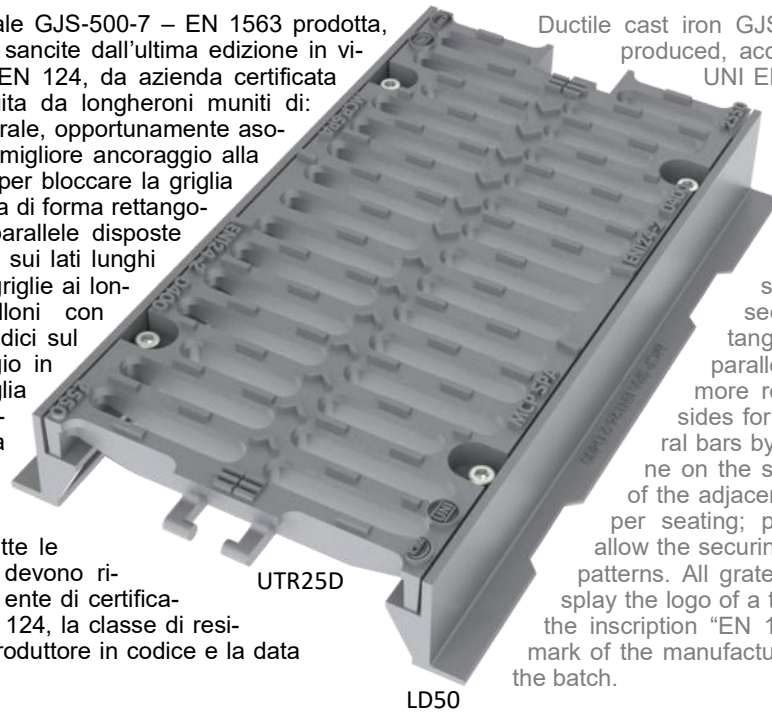

UTR25D

LD50



LD50



UTR30D

UTR40F

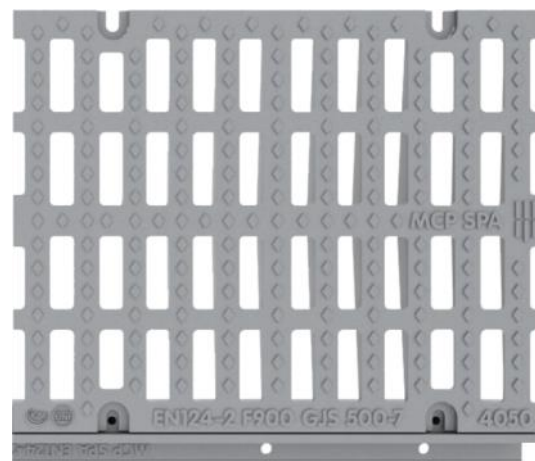

LF100

Montare i longheroni e le griglie nell'unità completa prima della posa in opera.



Assemble the lateral bars and the grates before installation.



UTRILLO 500 mm



2025

CODICE CODE	CLASSE CLASS	DIMENSIONI ESTERNE EXTERNAL DIMENSIONS mm	LUCE NETTA CLEAR OPENING mm	ALTEZZA HEIGHT mm	SCARICO DRAINAGE dm ²	PESO TOTALE TOTAL WEIGHT Kg.	PEZZI PER PEDANA PIECES ON PALLET n.	NOTE NOTES	LISTINO PRICE LIST €
UTR15C	C250	150X500		30	2,99	4,5	144	CONFORME D.P.R. 503/96 COMPLY WITH D.P.R. 503/96	43,00
UTR20C	C250	200X500		30	4,45	6,5	100	CONFORME D.P.R. 503/96 COMPLY WITH D.P.R. 503/96	61,00
UTR25C	C250	250X500		30	5,46	8	80	CONFORME D.P.R. 503/96 COMPLY WITH D.P.R. 503/96	75,00
UTR30C	C250	300X500		30	6,41	10,5	72	CONFORME D.P.R. 503/96 COMPLY WITH D.P.R. 503/96	99,00
UTR35C	C250	350X500		30	7,63	13	72	CONFORME D.P.R. 503/96 COMPLY WITH D.P.R. 503/96	122,00
UTR40C	C250	400X500		30	9,40	14,5	56	CONFORME D.P.R. 503/96 COMPLY WITH D.P.R. 503/96	136,00
UTR50C	C250	500X500		30	11,45	20	40	CONFORME D.P.R. 503/96 COMPLY WITH D.P.R. 503/96	188,00
UTR15D <i>i</i>	D400	150X500		30	3,41	6	144	BULLONI M10 A CORREDO M10 BOLTS INCLUDED	57,00
UTR20D <i>i</i>	D400	200X500		30	5,01	8	100	BULLONI M10 A CORREDO M10 BOLTS INCLUDED	<i>i</i> 75,00
UTR25D <i>i</i>	D400	250X500		30	6,35	10	80	BULLONI M10 A CORREDO M10 BOLTS INCLUDED	<i>i</i> 94,00
UTR30D <i>i</i>	D400	300X500		30	6,91	13	72	BULLONI M10 A CORREDO M10 BOLTS INCLUDED	<i>i</i> 122,00
UTR40D <i>i</i>	D400	400X500		30	10,82	19	48	BULLONI M10 A CORREDO M10 BOLTS INCLUDED	<i>i</i> 178,00
UTR50D <i>i</i>	D400	500X500		30	13,17	26	32	BULLONI M10 A CORREDO M10 BOLTS INCLUDED	<i>i</i> 244,00
UTR60D <i>i</i>	D400	600X500		30	14,31	40	32	BULLONI M10 A CORREDO M10 BOLTS INCLUDED	<i>i</i> 375,00
UTR70D <i>i</i>	D400	700X500		30	16,97	53	32	BULLONI M10 A CORREDO M10 BOLTS INCLUDED	<i>i</i> 497,00
UTR80D <i>i</i>	D400	800X500		30	20,26	60	32	BULLONI M10 A CORREDO M10 BOLTS INCLUDED	<i>i</i> 562,00
TD25100	D400	314X1072	210X1006	75		15	40	TELAIO PER GRIGLIA UTR25C E UTR25D FRAME SUITABLE FOR GRATE UTR25C AND UTR25D	141,00

Griglie e Canalette
Grates and Channels

73



UTRILLO 500 mm

**NEW
PRODUCT**



CODICE CODE	CLASSE CLASS	DIMENSIONI ESTERNE EXTERNAL DIMENSIONS mm	LUCE NETTA CLEAR OPENING mm	ALTEZZA HEIGHT mm	SCARICO DRAINAGE dm ²	PESO TOTALE TOTAL WEIGHT Kg.	PEZZI PER PEDANA PIECES ON PALLET n.	NOTE NOTES	LISTINO PRICE LIST €
UTR30F <i>i</i>	F900	300X500		30	5,08	25	28	BULLONI M10 A CORREDO M10 BOLTS INCLUDED	271,00
UTR40F <i>i</i>	F900	400X500		30	6,43	35	28	BULLONI M10 A CORREDO M10 BOLTS INCLUDED	380,00
UTR50F <i>i</i>	F900	500X500		30	8,76	61	10	BULLONI M10 A CORREDO M10 BOLTS INCLUDED	662,00
UTR60F <i>i</i>	F900	600X500		30	9,85	71	10	BULLONI M10 A CORREDO M10 BOLTS INCLUDED	770,00
UTR70F <i>i</i>	F900	700X500		30	12,10	86	8	BULLONI M10 A CORREDO M10 BOLTS INCLUDED	933,00
UTR80F <i>i</i>	F900	800X500		30	13,90	101	8	BULLONI M10 A CORREDO M10 BOLTS INCLUDED	1.095,00

Bulloni M10 a corredo solo per l'acquisto combinato di griglie di classe D400/F900 con telaio o coppia di longheroni.



M10 Bolts Included only in case of joint purchase of gratings class D400/F900 with frame or pair of lateral bars.

Certificazioni
Certifications



2025

Griglie e Canalette
Grates and Channels

UTRILLO

LONGHERONE

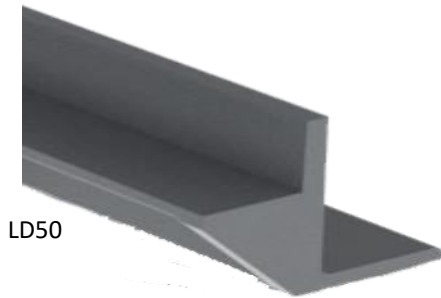

LD50

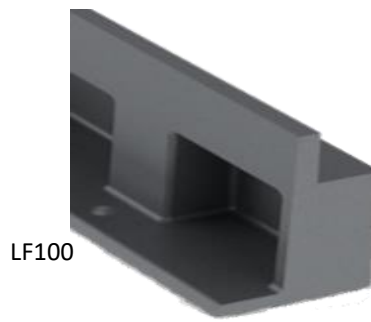

LF100

CODICE CODE	CLASSE CLASS	DIMENSIONI ESTERNE EXTERNAL DIMENSIONS mm	LUCE NETTA CLEAR OPENING mm	ALTEZZA HEIGHT mm	SCARICO DRAINAGE dm ²	PESO TOTALE TOTAL WEIGHT Kg.	PEZZI PER PEDANA PIECES ON PALLET n.	NOTE NOTES	LISTINO PRICE LIST €
LD50	D400	52X502		75		3	300	SINGOLO LONGHERONE PER GRIGLIE C250/D400 SINGLE BAR FOR GRATE C250/D400	34,00
LF100	F900	62X1004		100		13	100	SINGOLO LONGHERONE PER GRIGLIE F900 SINGLE BAR FOR GRATE F900	161,00
M10	VITE A TESTA CILINDRICA CON ESAGONO INCASSATO CYLINDRICAL HEAD SCREW HEX SOCKET							SINGOLO BULLONE SINGLE BOLT	1,00

74

LONGHERONE IN ACCIAIO ZINCATO

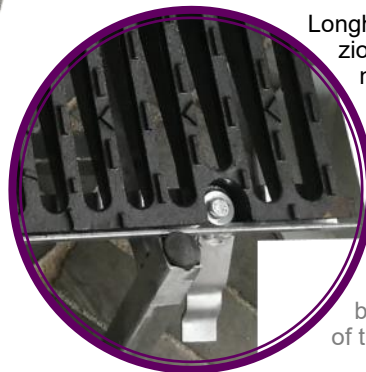

Longherone in acciaio zincato, per la protezione dei bordi esposti al traffico delle canalette in calcestruzzo gettate in opera, costituito da profilato sagomato ad "L" con zanche di fissaggio, fori per eventuale bullonatura delle griglie.

Galvanized steel Lateral bar, as protection of trafficked edges of cast-in-place concrete channels, constituted by an "L" shaped profile with fixing brackets and holes for eventual fastening of the gratings.

CODICE CODE	DIMENSIONI ESTERNE EXTERNAL DIMENSIONS mm	ALTEZZA HEIGHT mm	NOTE NOTES	LISTINO PRICE LIST €
ACCLONG100	34X1004	34	SINGOLO LONGHERONE PER GRIGLIE C250/D400 SINGLE BAR FOR GRATE C250/D400	87,00

NON PREVISTO DALLA NORMA EN124
NOT INCLUDED IN EN124 STANDARD

Bulloni M10 a corredo solo per l'acquisto combinato di griglie di classe D400/F900 con coppia di longheroni.



M10 Bolts Included only in case of joint purchase of gratings class D400/F900 with pair of lateral bars.

Certificazioni
Certifications





CANALETTE



VANTAGGI DEL CALCESTRUZZO POLIMERICO

Il cemento polimerico è ottenuto per miscelazione di inerti di quarzo, resine polimeriche o poliesteri e catalizzatori.

Vantaggi del cemento polimerico:

- ⇒ leggerezza;
- ⇒ ottenimento di superfici lisce, per una migliore fluidità dei liquidi evitando allo stesso tempo depositi di sostanze al loro interno;
- ⇒ resistenza alla corrosione, agli agenti chimici e ai carichi;
- ⇒ assorbimento acqua inferiore allo 0,1%;
- ⇒ antigelività;
- ⇒ possibilità di ottenere manufatti con buona precisione e di piccole dimensioni.

ADVANTAGES OF POLYMERIC CONCRETE

The polymer concrete is obtained by mixing quartz aggregates, polymeric resins or polyesters and catalysts.

Advantages of polymer concrete :

- ⇒ lightness;
- ⇒ smooth surfaces for better fluidity of liquid, avoiding at the same time deposits of substances inside them;
- ⇒ corrosion resistance, chemical resistance and loading resistance;
- ⇒ water absorption lower than 0.1% ;
- ⇒ frost resistance;
- ⇒ possibility to obtaining good precision and small size products.

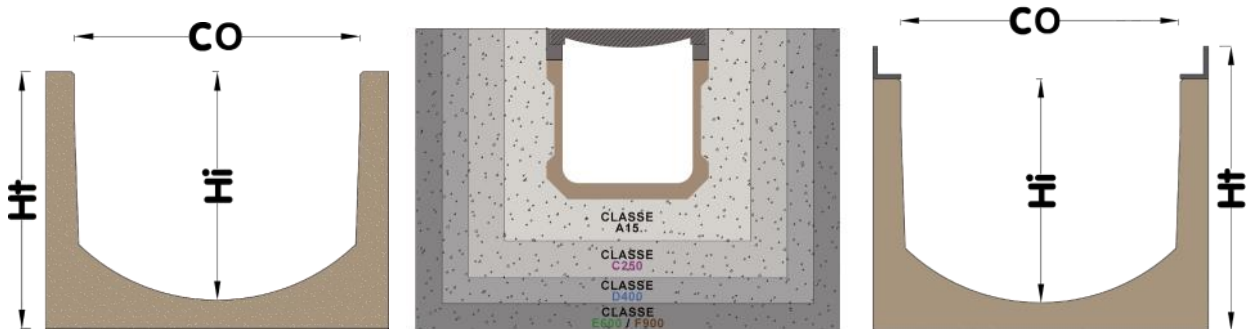

Griglie e Canalette
Grates and Channels

75

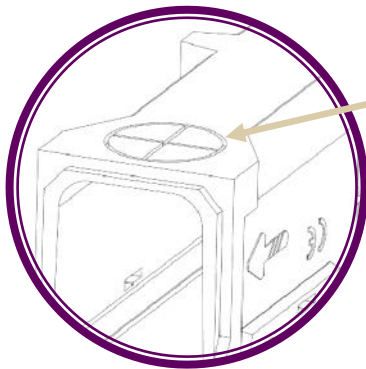

PREDISPOSIZIONE
INNESTO TUBAZIONE
PREDISPOSITION FOR
PIPE COUPLING

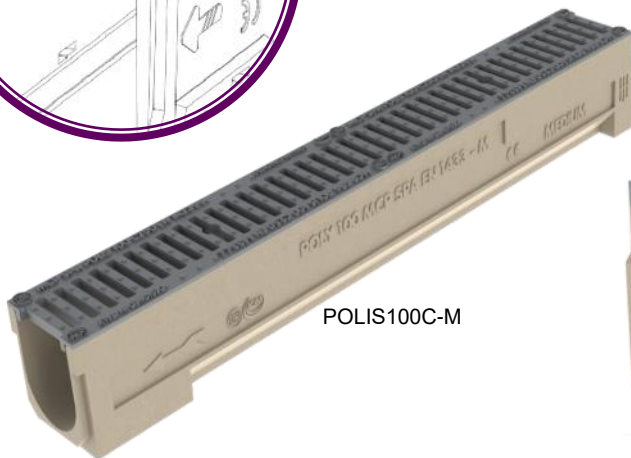

POLIS100C-M

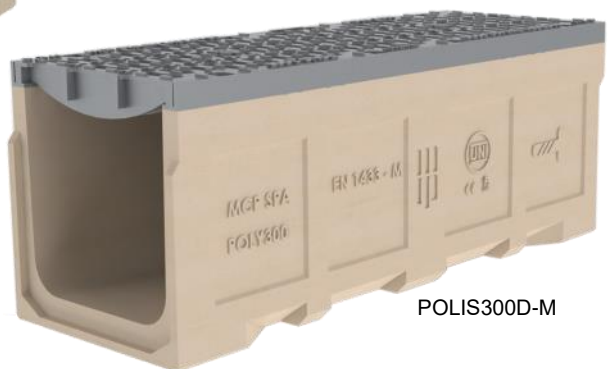

POLIS300D-M



PROFILO GRIGLIA C250
C250 GRATE SIDE VIEW

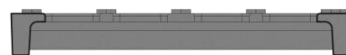

PROFILO GRIGLIA D400
D400 GRATE SIDE VIEW



Certificazioni
Certifications



2025

Griglie e Canalette
Grates and Channels

76

Certificazioni
Certifications

HYDROFLOW



Canalette in calcestruzzo polimerico complete di griglie in acciaio zincato prodotte da azienda certificata ISO 9001:2015, progettate e realizzate secondo la Norma UNI EN 1433, certificate a marchio CE. Il corpo canaletta, di lunghezza 1000mm e apertura libera **100mm-150mm**, è costituito da un canale realizzato in calcestruzzo polimerico senza pendenza interna; le griglie in acciaio zincato con classe di carrabilità A15. Il fissaggio delle griglie alla canaletta è ottenuto mediante **semplice pressione** assicurando l'opportuna stabilità e silenziosità.

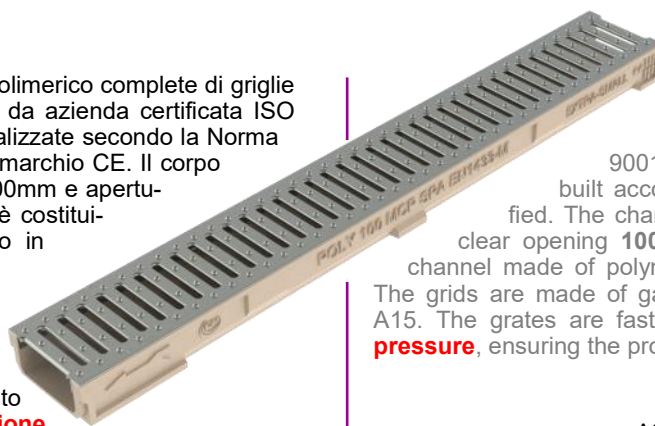

Channels in polymer concrete with grids of galvanized steel produced by certified ISO 9001:2015 company, designed and built according to UNI EN 1433, CE certified. The channel body, 1000mm in length and clear opening **100mm-150mm**, is constituted by a channel made of polymer concrete without inner slope. The grids are made of galvanized steel with loading class A15. The grates are fastened to the channel by **simple pressure**, ensuring the proper stability and silence.

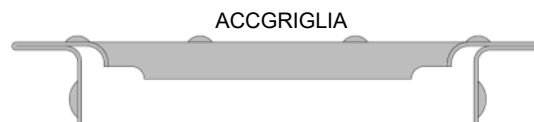

CODICE CODE	CLASSE CLASS	DIMENSIONI ESTERNE EXTERNAL DIMENSIONS mm	LUCE NETTA CLEAR OPENING mm (CO)	ALTEZZA TOTALE TOTAL HEIGHT mm (Ht)	ALTEZZA INTERNA INTERNAL HEIGHT mm (HI)	PESO TOTALE TOTAL WEIGHT Kg.	PEZZI PER PEDANA PIECES ON PALLET n.	SISTEMA DI FISSAGGIO GRIGLIA FASTENING SYSTEM	LISTINO PRICE LIST €
HYDRO100A-XS	A15	130X1000	100	64	50	7,2	104	A PRESSIONE BY PRESSURE	71,00
HYDRO100A-S	A15	130X1000	100	101	85	9,4	72	A PRESSIONE BY PRESSURE	89,00
HYDRO100A-M	A15	130X1000	100	144	125	12,7	48	A PRESSIONE BY PRESSURE	125,00
HYDRO150A-S	A15	198X1000	150	125	100	17,7	35	A PRESSIONE BY PRESSURE	178,00
HYDRO150A-M	A15	198X1000	150	200	175	25,1	25	A PRESSIONE BY PRESSURE	249,00
ACCGRIGLIA13	A15	130X1000	GRIGLIA SE ACQUISTATATA SINGOLARMENTE - SOLE GRATING						36,00
ACCGRIGLIA19	A15	198X1000	GRIGLIA SE ACQUISTATATA SINGOLARMENTE - SOLE GRATING						60,00



AREA SEZIONE CANALETTA 5.000mm²
CHANNEL SECTION AREA 5.000mm²

TAPPO



Per unire il tappo alla canaletta consigliamo:

- silicone acetico nel caso di deflusso di acque reflue;
- adesivo poliuretano nel caso di deflusso di derivati del petrolio.



For joining of the end cap to the channel, we suggest:

- in the case of outflow of waste water: acetic silicone;
- in the case of outflow of petroleum derivatives: polyurethane adhesive.

CODICE CODE	SISTEMA DI FISSAGGIO GRIGLIA FASTENING SYSTEM	LISTINO PRICE LIST €
ENDCAP100XS	TAPPO IDONEO PER CANALETTA LUCE 100mm MISURA XS CAP SUITABLE FOR CHANNEL WITH CLEAR OPENING 100mm SIZE XS	9,00
ENDCAP100S	TAPPO IDONEO PER CANALETTA LUCE 100mm MISURA S CAP SUITABLE FOR CHANNEL WITH CLEAR OPENING 100mm SIZE S	9,00
ENDCAP100M	TAPPO IDONEO PER CANALETTA LUCE 100mm MISURA M CAP SUITABLE FOR CHANNEL WITH CLEAR OPENING 100mm SIZE M	9,00
ENDCAP150S	TAPPO IDONEO PER CANALETTA LUCE 150mm MISURA S CAP SUITABLE FOR CHANNEL WITH CLEAR OPENING 150mm SIZE S	15,00
ENDCAP150M	TAPPO IDONEO PER CANALETTA LUCE 150mm MISURA M CAP SUITABLE FOR CHANNEL WITH CLEAR OPENING 150mm SIZE M	15,00
ENDCAP200M	TAPPO IDONEO PER CANALETTA LUCE 200mm MISURA M CAP SUITABLE FOR CHANNEL WITH CLEAR OPENING 200mm SIZE M	33,00
ENDCAP250M	TAPPO IDONEO PER CANALETTA LUCE 250mm MISURA M CAP SUITABLE FOR CHANNEL WITH CLEAR OPENING 250mm SIZE M	42,00
ENDCAP300M	TAPPO IDONEO PER CANALETTA LUCE 300mm MISURA M CAP SUITABLE FOR CHANNEL WITH CLEAR OPENING 300mm SIZE M	45,00



POLIS



2025

Canalette in calcestruzzo polimerico, complete di griglie in ghisa e longheroni ove previsti, prodotte da azienda certificata ISO 9001:2015, progettate e realizzate secondo la Norma UNI EN 1433 e certificate a marchio CE. Il corpo canaletta, di lunghezza 1000mm e apertura libera di **100mm-150mm-205mm-250mm-300mm-312mm**, è costituito da un canale realizzato in calcestruzzo polimerico senza pendenza interna. Le griglie sono in ghisa sferoidale GJS500-7 con classe di carrabilità dalla C250 alla D400. Il fissaggio delle griglie alla canaletta è ottenuto, a seconda del modello, mediante sistema a ponte costituito da una barretta centrale (cavalotto) e bullone oppure attraverso bulloni avvitati sui longheroni in ghisa, entrambe le soluzioni assicurano opportuna stabilità e silenziosità.

Channels in polymer concrete, with cast iron grates and lateral bars where expected, produced by certified ISO 9001:2015 company, designed and built according to UNI EN 1433 and CE certified. The channel body, 1000mm in length and clear opening of **100mm-150mm-205mm-250mm-300mm-312mm**, is constituted by a channel made of polymer concrete without inner slope. Grids are in ductile iron GJS500-7, with loading class from C250 to D400. The grates are fastened to the channel, depending on the model, by a bridge system consisting of a small bar and bolt or by bolts screwed through the cast iron side members, to ensure the proper stability and silence.



POLIS150D-M

CODICE CODE	CLASSE CLASS	DIMENSIONI ESTERNE EXTERNAL DIMENSIONS mm	LUCE NETTA CLEAR OPENING mm (CO)	ALTEZZA TOTALE TOTAL HEIGHT mm (Ht)	ALTEZZA INTERNA INTERNAL HEIGHT mm (Hi)	PESO TOTALE TOTAL WEIGHT Kg.	PEZZI PER PEDANA PIECES ON PALLET n.	SISTEMA DI FISSAGGIO GRIGLIA FASTENING SYSTEM	LISTINO PRICE LIST €
POLIS100C-XS	C250	130X1000	100	65	50	11,5	104	A PONTE WITH CLAMP	107,00
POLIS100C-S	C250	130X1000	100	102	85	13,7	72	A PONTE WITH CLAMP	127,00
POLIS100C-M	C250	130X1000	100	145	125	17	48	A PONTE WITH CLAMP	163,00
POLIS150C-S	C250	198X1000	150	126	100	24,5	40	A PONTE WITH CLAMP	252,00
POLIS150C-M	C250	198X1000	150	201	175	31,9	25	A PONTE WITH CLAMP	317,00
POLIS150D-S	D400	198X1000	150	147	100	32,2	35	CON BULLONI WITH BOLTS	313,00
POLIS150D-M	D400	198X1000	150	222	181	37,5	25	CON BULLONI WITH BOLTS	377,00
POLIS200D-M	D400	265X1000	205	265	205	60	16	CON BULLONI WITH BOLTS	581,00
POLIS250D-M	D400	310X1000	250	306	245	75,6	9	CON BULLONI WITH BOLTS	727,00
POLIS300D-M	D400	372X1000	312	306	245	90,7	9	CON BULLONI WITH BOLTS	890,00
GSGRIGLIA13	C250	130x500	GRIGLIA SE ACQUISTATATA SINGOLARMENTE - SOLE GRATING						69,00
GSGRIGLIA19	C250	198x500	GRIGLIA SE ACQUISTATATA SINGOLARMENTE - SOLE GRATING						95,00

AREA SEZIONE CANALETTA 5000mm²
CHANNEL SECTION AREA 5000mm²



POLIS150C-S



PROFILO GRIGLIA C250
C250 GRATE SIDE VIEW

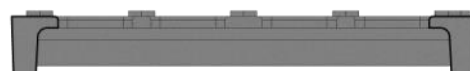

PROFILO GRIGLIA D400
D400 GRATE SIDE VIEW

Griglie e Canalette
Grates and Channels

77



Certificazioni
Certifications



2025

TUBI IN GHISA CENTRIFUGATA PER PLUVIALI

CENTRIFUGED CAST-IRON PIPES

Tubazioni per Pluviali
Downspout

78

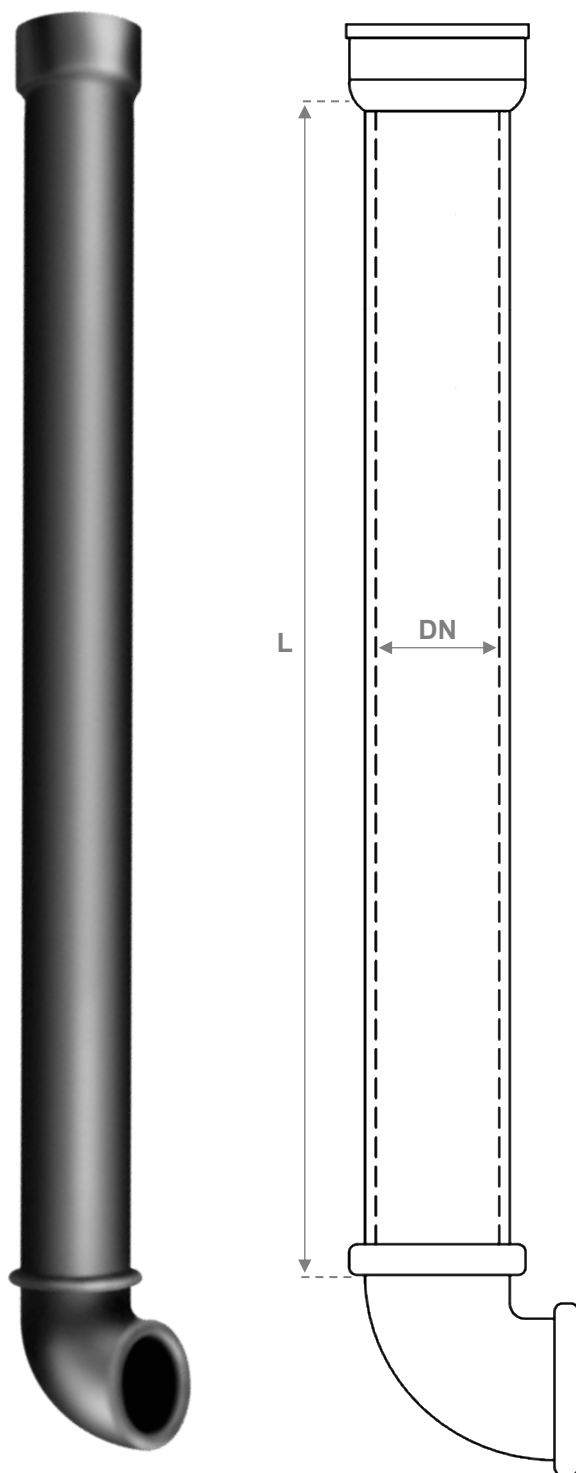

CARATTERISTICHE:

⇒ Tubo in ghisa, realizzato per centrifugazione, con superficie esterna liscia, bicchiere e curva finale per pluviali verticali di scarico di acque piovane senza pressione.

Cast iron pipe for downspout, made by centrifugation, external smooth finishing, with socket and final bend.

www.mcpomicino.it
www.mcpspa.it

CODICE CODE	DIAMETRO NOMINALE NOMINAL DIAMETER DN mm	LUNGHEZZA LENGHT L mt	PESO TOTALE TOTAL WEIGHT Kg.	PEZZI PER PEDANA PIECES ON PALLET n.	NOTE NOTES	LISTINO PRICE LIST €
TB80/2	70	2	18	48	TERMINALE CON CURVA PIPE WITH CURVE	222,00
TB100/2	100	2	25	30	TERMINALE CON CURVA PIPE WITH CURVE	308,00

**SONO I DETTAGLI A FARE LA DIFFERENZA.
THE DIFFERENCE IS IN THE DETAILS.**



ARREDO URBANO E DA GIARDINO



STREET AND PARK FURNITURE



AMÈNAGEMENT URBAIN



STRASSEN-UND STADTMÖBEL



MOBILIARIO URBANO



Designed by MCP SPA® in Italy

PANCHINE



ITALIA Panchina stile ITALIA costituita da 2 fiancate di sostegno in ghisa con appoggi predisposti per l'ancoraggio al terreno mediante tasselli, unite tra loro da 3 tiranti in acciaio zincato diametro 12 mm filettati alle estremità e fissati con dado e copri dado ottonati; lunghezza 1700 mm (1500 mm con tubolari in ferro) larghezza 540 mm altezza 740 mm. Seduta e spalliera realizzate mediante 10 doghe ad angoli smussati in legno massello Pino russo stagionato trattato per ambienti esterni o tubolari in ferro alloggiati in apposite sedi ricavate nella parte interna delle fiancate.

ITALIA style bench, consisting of 2 cast iron supporting sides preset for the securing to the ground by screwed anchors and assembled together by 3 galvanized steel tie bars 12 mm diameter, threaded at the extremities and fixed by brass plate nuts and lock nuts; length 1700 mm (1500 mm with iron tubulars) width 540 mm height 740 mm. Seat and back rest consist of 10 staves with bevelled corners in seasoned russian pinewood treated for external use or tubulars in iron fitted in proper seatings, obtained in the sides.

CODICE	LUNGHEZZA	LARGHEZZA	ALTEZZA	PESO TOTALE	MATERIALE DOGHE	N. DOGHE	DIM. DOGA	LISTINO
CODE	LENGHT	WIDTH	HEIGHT	TOTAL WEIGHT	MATERIAL OF STAVES	STAVES N.	STAVE DIM.	PRICE LIST
	mm	mm	mm	Kg.		pz/pcs	mm	€
ITALIAPINO	1700	540	740	66	PINO RUSSO	10	1680X55X45	992,00
ITALIAFERRO	1500	540	740	77	FERRO	10	1480X55X45	1.469,00
ITALIA	COPPIE DI SPALLE IN GHISA PAIR OF SUPPORTING CAST IRON SIDES			36				533,00
ITALIAKITPINO	KIT DOGHE IN LEGNO PINO RUSSO CON TIRANTI E BULLONERIA KIT OF RUSSIAN PINWOOD STAVES PROVIDED WITH FASTNERS AND BOLTS			30	PINO RUSSO	10	1680X55X45	459,00
ITALIKITFERRO	KIT TUBOLARI IN FERRO CON TIRANTI E BULLONERIA KIT OF IRON TUBOLARS PROVIDED WITH FASTNERS AND BOLTS			41	FERRO	10	1480X55X45	936,00

ISTRUZIONI DI MONTAGGIO

- 1) Posizionare le due fiancate considerando la lunghezza delle doghe.
- 2) Inserire i tre tiranti nelle apposite asole.
- 3) Avvitare i dadi con un minimo serraggio.
- 4) Inserire le doghe nelle sedi predisposte.
- 5) Avvitare i dadi in egual misura da entrambi i lati ed assicurarsi del perfetto assemblaggio.
- 6) Avvitare i controdadi.
- 7) Fissare la panchina al terreno mediante tirafondi che arponano lo zoccolo nella gola predisposta.

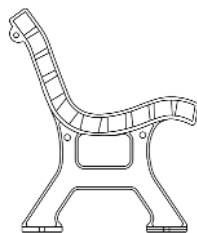

INTERNO
INTERNAL

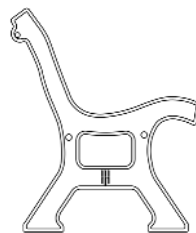

ESTERNO
EXTERNAL

INSTALLATION INSTRUCTIONS

- 1) Place the two sides according to the length of the staves.
- 2) Insert the three tie rods in the proper holes.
- 3) Tighten the nuts with a loose clamping.
- 4) Insert the staves in the preset seatings.
- 5) Tighten the nuts on both sides in order to ensure a proper fastening.
- 6) Screw the lock nuts.
- 7) Fix the bench to the ground by logbolts which secure the basement in the preset groove.



VIENNA Panchina stile VIENNA costituita da 2 fiancate di sostegno in ghisa complete di braccioli ornati con motivi a voluta e predisposta per l'appoggio al terreno mediante apposita zoccolatura, lunghezza 1600 mm larghezza 640 mm altezza 820 mm. Seduta realizzata mediante 4 doghe ad angoli smussati in legno massello Pino russo stagionato trattato per ambienti esterni di sezione 80 mm (larghezza) x 32 mm (altezza) da forare ognuna in 4 punti per l'opportuno fissaggio ai sostegni con bulloni passanti a testa arrotondata in acciaio zincato. Spalliera costituita da 1 dogha come sopra descritta di sezione 180 mm (larghezza) x 32 mm (altezza).

VIENNA style bench, consisting of 2 cast iron supporting sides, provided with volute motifs decorated arms; pre-set for being laid on ground by appropriate socles, length 1600 mm, width 640 mm, height 820 mm. The seat consists of 4 staves with bevelled corners in solid seasoned Russian pinewood, treated for external use - size 80 mm (width) x 32 mm (height). Each stave is drilled in 4 points for a proper fixing to the supports by round-head zinc-plated steel bolts. The back rest consists of 1 stave as above described, size 180 mm (width) x 32 mm (height).

CODICE	LUNGHEZZA	LARGHEZZA	ALTEZZA	PESO TOTALE	MATERIALE DOGHE	N. DOGHE	DIM. DOGA	LISTINO
CODE	LENGHT	WIDTH	HEIGHT	TOTAL WEIGHT	MATERIAL OF STAVES	STAVES N.	STAVE DIM.	PRICE LIST
	mm	mm	mm	Kg.		pz/pcs	mm	€
VIENNA PINO	1600	640	820	76	PINO RUSSO	1 4	1600X180X32 1600X80X32	1.124,00
VIENNA	COPPIE DI SPALLE IN GHISA PAIR OF SUPPORTING CAST IRON SIDES			46				680,00
VIENNAKITPINO	KIT DOGHE IN LEGNO PINO RUSSO CON BULLONERIA KIT OF RUSSIAN PINWOOD STAVES PROVIDED WITH BOLTS			30	PINO RUSSO	1 4	1600X180X32 1600X80X32	444,00

ISTRUZIONI DI MONTAGGIO

- 1) Posizionare le due fiancate considerando la lunghezza delle doghe.
- 2) Forare le doghe utilizzando come guida i fori presenti sulle coppia di fiancate e fissarle inserendovi i bulloni.
- 3) Avvitare i dadi assicurandosi del perfetto assemblaggio.



INTERNO
INTERNAL



ESTERNO
EXTERNAL

INSTALLATION INSTRUCTIONS

- 1) Place the two sides considering the length of the staves.
- 2) Drill the holes in the staves using, as track, the slots present on the pairs of cast iron sides, and fix them by bolts.
- 3) Tighten the nuts in order to ensure a proper fastening.

PANCHINE



2025

Panchina stile Lisbona costituita da 2 strutture di sostegno in ghisa con zoccolature alla base predisposte per l'appoggio al terreno; lunghezza 1800 mm, larghezza 730 mm altezza 845 mm. Seduta e spalliera realizzate mediante 5 doghe ad angoli smussati in legno massello Pino russo stagionato trattato per ambienti esterni di sezione 1800 mm (lunghezza) x 110 mm (larghezza) x 40 mm (spessore) da forare per l'opportuno fissaggio ai sostegni con bulloni.

LISBONA



LISBONA style bench, consisting of 2 cast iron supports, provided with socles at the base, preset for being laid on ground; length 1800 mm. Seat and back rest consist of 5 staves with bevelled corners in seasoned russian pine wood, treated for external use - size 1800 mm (length) x 110 mm (width) x 40 mm (thickness) to be drilled for a proper fastening to the supports by bolts.

CODICE	LUNGHEZZA	LARGHEZZA	ALTEZZA	PESO TOTALE	MATERIALE DOGHE	N. DOGHE	DIM. DOGA	LISTINO
CODE	LENGHT	WIDTH	HEIGHT	TOTAL WEIGHT	MATERIAL OF STAVES	STAVES N.	STAVE DIM.	PRICE LIST
	mm	mm	mm	Kg.		pz/pcs	mm	€
LISBONAPINO	1800	730	850	64	PINO RUSSO	5	1800X110X40	947,00
LISBONA	COPPIE DI SPALLE IN GHISA PAIR OF SUPPORTING CAST IRON SIDES			29				429,00
LISBONAKITPINO	KIT DOGHE IN LEGNO PINO RUSSO CON BULLONERIA KIT OF RUSSIAN PINEWOOD STAVES PROVIDED WITH BOLTS			35	PINO RUSSO	5	1800X110X40	518,00

ISTRUZIONI DI MONTAGGIO

- 1) Posizionare i due sostegni in ghisa considerando la lunghezza delle doghe.
- 2) Forare le doghe utilizzando come guida i fori presenti sulla coppia di sostegni e fissarle inserendovi i bulloni.
- 3) Avvitare i dadi assicurandosi del perfetto assemblaggio.

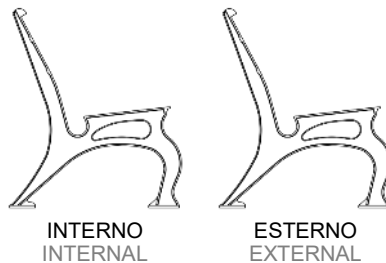

INTERNO
INTERNAL

ESTERNO
EXTERNAL

INSTALLATION INSTRUCTIONS

- 1) Place the two supports considering the length of the stave.
- 2) Drill the holes in the staves using, as track, the slots on the pairs of supports, and fix them by bolts.
- 3) Tighten the nuts in order to ensure a proper fastening.

Arredo urbano e da giardino
Street and park furniture

Panchina stile Bruxelles costituita da 2 fiancate di sostegno in ferro zincato a caldo di sezione rettangolare, con zoccolature alla base predisposte per l'appoggio al terreno e/o l'ancoraggio mediante tasselli, lunghezza 1660 mm, larghezza 550 mm e altezza 730 mm. Formate da 7 doghe ad angoli smussati in legno massello Iroko stagionato trattato per ambienti esterni, 4 da 1500x70x40 mm per la seduta e 3 da 1500x60x40 mm per la spalliera (pannelli, composti da doghe di tubolari in ferro zincato a caldo per il modello BRUXELLESFERRO), fissati alle fiancate mediante bulloni in acciaio.

BRUXELLES

Bruxelles style bench, consisting of 2 galvanized iron supporting sides with rectangular section, provided with socles at the base, pre-set for being laid on the ground and/or for the securing with anchors bolts, length 1660 mm, width 550 mm, height 730 mm. Seat and back consisting of 7 staves with bevelled corners in solid seasoned Iroko wood, treated for external use, of which 4 for the seat with dimensions 1500x70x40 mm and 3 for the back with dimensions 1500x60x40 mm, secured to the sides by means of steel bolts. (for model BRUXELLESFERRO, seat and back are constituted by panels made by galvanized iron tubular slats)



BRUXELLESIROKO

BRUXELLESFERRO

CODICE	LUNGHEZZA	LARGHEZZA	ALTEZZA	PESO TOTALE	MATERIALE DOGHE	N. DOGHE	DIM. PANNELLO	LISTINO
CODE	LENGHT	WIDTH	HEIGHT	TOTAL WEIGHT	MATERIAL OF STAVES	STAVES N.	PANELS DIM.	PRICE LIST
	mm	mm	mm	Kg.		pz/pcs	mm	€
BRUXELLESIROKO	1660	550	730		IROKO	3 4	1500X60X40 1500X70X40	2.104,00
BRUXELLESFERRO	1750	530	820		FERRO	1 PANNELLO (PANEL) 1 PANNELLO (PANEL)	1590X385X30 1590X250X30	1.563,00

ISTRUZIONI DI MONTAGGIO

- 1) Posizionare le due fiancate considerando la lunghezza dei pannelli.
- 2) Fissare i pannelli alle fiancate, utilizzando come guida i fori presenti, inserendovi i bulloni.
- 3) Avvitare i dadi assicurandosi del perfetto assemblaggio.

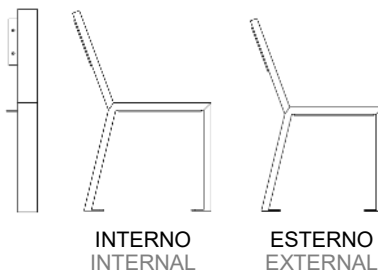

INTERNO
INTERNAL

ESTERNO
EXTERNAL

INSTALLATION INSTRUCTIONS

- 1) Place the two sides considering the length of the panels.
- 2) Fix the panels to the sides using as track, the holes present on the sides, inserting the bolts.
- 3) Tighten the nuts in order to ensure a proper fastening.

Per il montaggio delle panchine è consigliato l'impiego di almeno due installatori.



We suggest to use of at least two workers for the installation of the benches.

Prodotti verniciati di colore grigio ghisa
Products painted in grey cast iron

81



2025

Arredo urbano e da giardino
Street and park furniture

82

Linea completa arredo urbano Full catalogue of urban furnishing
www.mcpomicino.it/download/



FONTANE



MILANO Fontana in ghisa stile MILANO completa di rubinetto in ottone del tipo a leva oppure a pulsante, costituita da un corpo prismatico cavo a sezione quadra con rilievi decorativi orizzontali chiuso alla sommità da una piastra bullonata e da un pomo ornato e corredato alla base da una vasca di forma semicircolare munita di griglia superiore per l'appoggio.

Cast-iron fountain, MILANO style, provided with lever or push-button brass tap, consisting of a prismatic body with square section adorned with horizontal relieves, closed at the top by a bolted plate and an adorned knob; equipped with semicircular basin with grating.

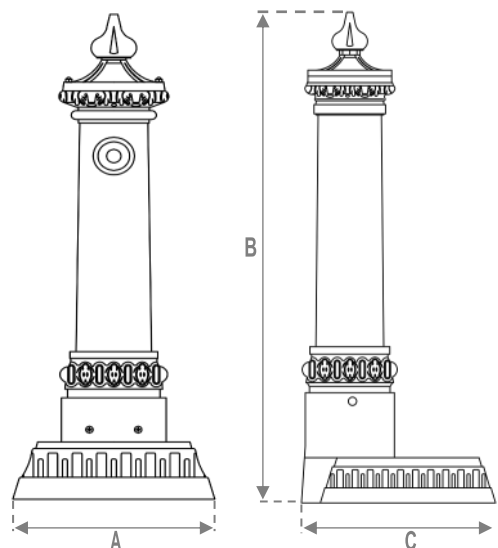

CODICE	LARGHEZZA (A)	ALTEZZA (B)	PROFONDITA' (C)	PESO TOTALE	COLORE	LISTINO
CODE	WIDTH	HEIGHT	DEEPNESS	TOTAL WEIGHT	COLOR	PRICE LIST
	mm	mm	mm	Kg.		€
FONT8	350	850	390	40	GRIGIO / VERDE GREY / GREEN	552,00
FONT10	415	1100	465	63	GRIGIO / VERDE GREY / GREEN	746,00
FONT12	460	1240	510	80	GRIGIO / VERDE GREY / GREEN	947,00
FONT14	620	1400	640	120	GRIGIO / VERDE GREY / GREEN	1.538,00
RUBINETTO IN OTTONE SE ACQUISTATO SINGOLARMENTE - SOLE BRASS TAP						69,00



A SCARICO LIBERO
FREE WATER OUTFLOW



NAPOLI Fontana in ghisa stile NAPOLI completa di rubinetto in ottone del tipo a leva oppure a pulsante, costituita da un corpo tronco conico cavo delimitato, nella parte inferiore, da vasca di forma circolare munita di griglia superiore per l'appoggio, e nella parte superiore da un pomo a forma conica.

Cast-iron fountain, NAPLES style, provided with brass tap lever or push-button, consisting of a conical body delimited: in the lower part, by a circular basin provided with grating, and at the top by a knob of conical shape.

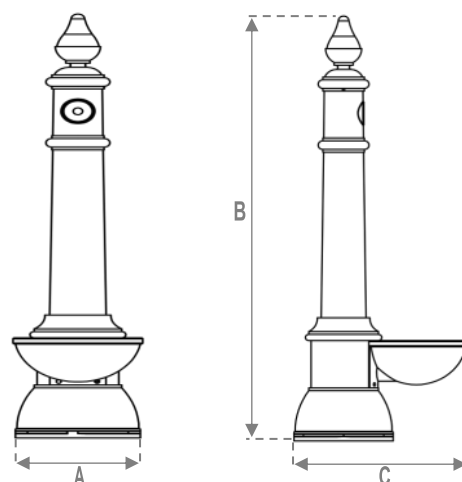

CODICE	BASE (A)	ALTEZZA (B)	PROFONDITA' (C)	PESO TOTALE	COLORE	LISTINO
CODE	BASE	HEIGHT	DEEPNESS	TOTAL WEIGHT	COLOR	PRICE LIST
	mm	mm	mm	Kg.		€
FONT12/NA	290	1230	460	48	GRIGIO / VERDE GREY / GREEN	592,00
RUBINETTO IN OTTONE SE ACQUISTATO SINGOLARMENTE - SOLE BRASS TAP						69,00



A SCARICO LIBERO
FREE WATER OUTFLOW

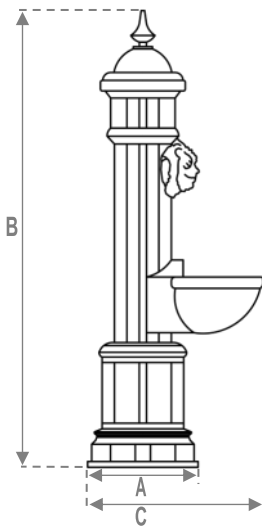

Fontana in ghisa stile ROMA completa di rubinetto in ottone del tipo a leva oppure a pulsante, costituita da un corpo prismatico cavo delimitato, nella parte inferiore, da vasca di forma circolare munita di griglia superiore per l'appoggio, e nella parte superiore da un decoro raffigurante una testa leonina, chiusa alla sommità da un coperchio con puntale.

ROMA

Cast-iron fountain Roma style, with lever or push button brass tap, consisting of a hollow prismatic body closed, at the top, by a round basin provided with upper supporting grid; the top part shows also a lion head decoration closed at the top by a lid with a toecap.



CODICE	BASE (A)	ALTEZZA (B)	PROFONDITA' (C)	PESO TOTALE	COLORE	LISTINO
CODE	BASE	HEIGHT	DEEPPNESS	TOTAL WEIGHT	COLOR	PRICE LIST
	mm	mm	mm	Kg.		€
FONT12/RO	290	1200	460	75	GRIGIO / VERDE GREY / GREEN	1.479,00
RUBINETTO IN OTTONE SE ACQUISTATO SINGOLARMENTE - SOLE BRASS TAP						69,00



A SCARICO LIBERO - IL RUBINETTO VA MONTATO SENZA ROSONE
FREE WATER OUTFLOW - THE TAP MUST BE INSTALLED WITHOUT ROSETTE

Arredo urbano e da giardino
Street and park furniture



ISTRUZIONI DI MONTAGGIO DEL RUBINETTO INSTALLATION INSTRUCTIONS OF THE BRASS TAPS

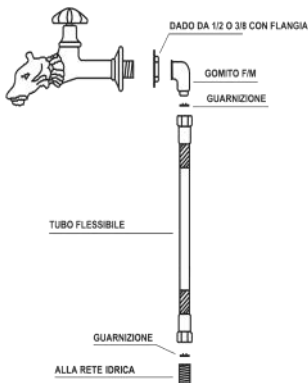

Premessa: i rubinetti in dotazione sono filettati all'interno 3/8 e all'esterno 1/2.

Remark: the brass taps supplied are threaded internally 3/8 and externally 1/2.

- 1) Togliere il cappello della fontana.
 - 2) Posizionare nella sua sede il rubinetto e bloccarlo dall'interno con dado da 3/8.
 - 3) Avvitare, dal retro del rubinetto, il niples a gomito e il tubo flessibile. Mettere guarnizione di tenuta.
 - 4) Collegare il tubo flessibile alla rete idrica.
- 1) Remove the top of the fountain.
 - 2) Position the tap in its proper housing and lock it from the inside with a nut 3/8
 - 3) Screw the 90° elbow from the back of the tap, and the hose. Put sealing gasket.
 - 4) Connect the hose to the water system.



A PULSANTE
PUSH-BUTTON

RUBINETTI



A LEVA
LEVER

Prodotti verniciati di colore grigio ghisa
Products painted in grey cast iron



2025

Arredo urbano e da giardino
Street and park furniture

FONTANE



VENEZIA Fontana a muro in ghisa stile VENEZIA di altezza totale 750 mm larghezza vasca 460 mm completa di rubinetto in ottone del tipo a leva oppure a pulsante, costituita da una vasca semicircolare con bordo arrotondato e stampato a rilievo e da una spalla murale ornata a disegno barocco.

Cast-iron wall fountain, VENEZIA style, of a total height 750 mm, with a tub width 460 mm, provided with lever or push-button brass tap, constituted by a semicircular tub with rounded edge and printed in relief and a background decorated in baroque design.

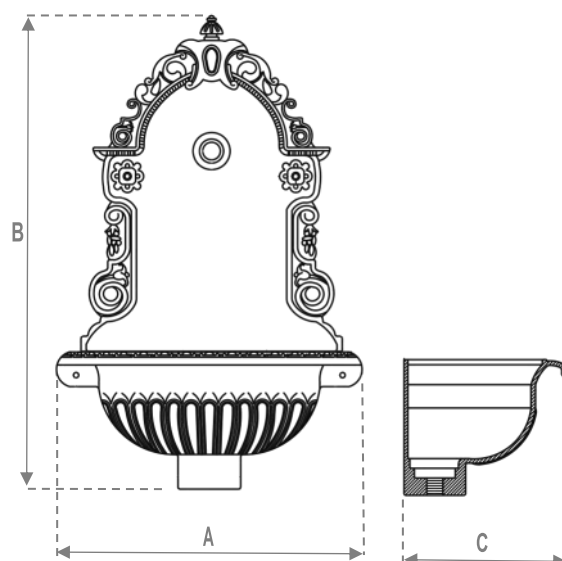

CODICE	LARGHEZZA (A)	ALTEZZA (B)	PROFONDITA' (C)	PESO TOTALE	COLORE	LISTINO
CODE	WIDTH	HEIGHT	DEEPPNESS	TOTAL WEIGHT	COLOR	PRICE LIST
	mm	mm	mm	Kg.		€
FONTMU i	460	750	250	24	GRIGIO / VERDE GREY / GREEN	355,00
RUBINETTO IN OTTONE SE ACQUISTATO SINGOLARMENTE - SOLE BRASS TAP						69,00

84

Linea completa arredo urbano
Full catalogue of urban furnishing
www.mcpomicino.it/download/
DOWNLOAD

FONTZA



UGELLO

ZAMPILLO Fontana in ghisa stile ZAMPILLO, completa di ugello in ottone, di altezza totale 800 mm diametro vasca 570 mm, costituita da una vasca circolare con bordo arrotondato e stampato a rilievo con fori di scarico e da una base a colonna ornata a disegno barocco con foglie d'acanto su base ottagonale di dimensione 270 mm.

Cast-iron Jet fountain ZAMPILLO style, with brass tap, of a total height of 800 mm, with a tub of 570 mm diameter. It consists of a circular tub with rounded edge and printed in relief, with drain holes and as a base, a decorated column in baroque design with acanthus leaves on an octagonal base of dimension 270 mm.



CARPA

CODICE	BASE (A)	ALTEZZA (B)	PROFONDITA' (C)	PESO TOTALE	COLORE	LISTINO
CODE	BASE	HEIGHT	DEEPPNESS	TOTAL WEIGHT	COLOR	PRICE LIST
	mm	mm	mm	Kg.		€
FONTZA i	Ø 270	800	Ø 570	80	GRIGIO / VERDE GREY / GREEN	1.577,00
FONTZA/C ii	Ø 270	800	Ø 570	80	GRIGIO / VERDE GREY / GREEN	2.839,00

UGELLO CON REGOLATORE DI FLUSSO
NOZZLE WITH FLOW CONTROLUGELLO A FORMA DI "CARPA" CON REGOLATORE DI FLUSSO
"CARP" SHAPE NOZZLE WITH FLOW CONTROL

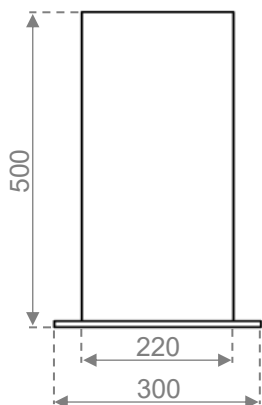

Dissuasore stradale in ferro zincato a caldo, stile **CHIAIA**, costituito da un colonnino cilindrico cavo, \varnothing 219mm spessore 30/10, e base circolare, \varnothing 300 mm, per l'ancoraggio a suolo mediante tirafondi. Verniciatura a polvere con RAL a scelta dell'acquirente.

Hot galvanized iron Bollard, CHIAIA style, consisting of a hollow column with a cylindrical section, \varnothing 219 mm, thickness 30/10, and a circular base \varnothing 300 mm, for anchoring to the ground by means of bolts. Powder coating with RAL chosen by the client.

Ancoraggio con tirafondi
Anchorage by logbolts

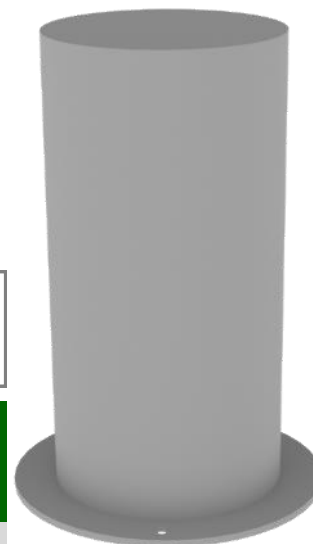

CODICE	ALTEZZA	BASE	PESO TOTALE	NOTE	LISTINO
CODE	HEIGHT	BASE	TOTAL WEIGHT	NOTES	PRICE LIST
	mm	mm	Kg.		€
FERDISS50	500	\varnothing 300	12,5		678,00

Arredo urbano e da giardino
Street and park furniture

85

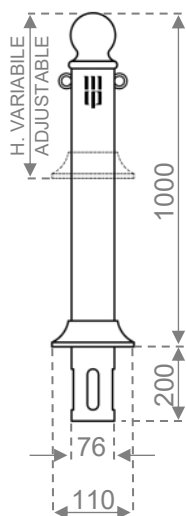

Dissuasore stradale in ferro, stile **GINEVRA**, costituito da un colonnino cilindrico cavo, ornato alla sommità da un pomello sferico (\varnothing 80 mm) e, in opzione, nella parte alta da 2 anelli diametralmente opposti per l'eventuale aggancio di catene. Base chiusa da un collarino di ornamento circolare predisposto all'ancoraggio fisso in fondazione mediante apposita zoccolatura.

Iron bollard, GINEVRA style, consisting of an hollow cylindrical column decorated at the top by a spherical knob (\varnothing 80 mm) and optionally provided in the upper part by two rings diametrically opposed for the possible hooking of chains. The base is adorned with a round collar and it has appropriate socles for a fixed anchoring to the foundation.

Ancoraggio fisso in fondazione
Anchorage fixed in base

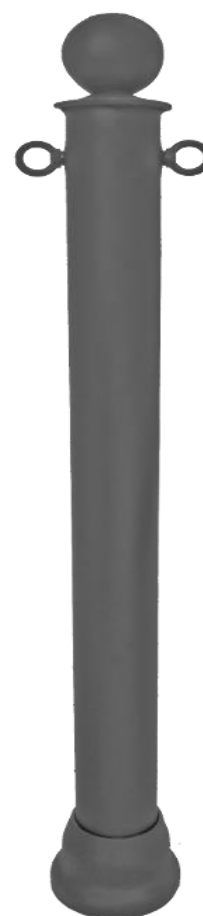

CODICE	ALTEZZA	BASE	PESO TOTALE	NOTE	LISTINO
CODE	HEIGHT	BASE	TOTAL WEIGHT	NOTES	PRICE LIST
	mm	mm	Kg.		€
FERDISS100	1000	\varnothing 110	7	OCCHIELLI PORTACATENA OPZIONALI EYELETS FOR CHAIN AS OPTIONAL	259,00



COLLARINO MOBILE (ALTEZZA MASSIMA 1000 mm F.T.)
ROUND COLLAR MOVABLE (MAX HEIGHT 1000 mm)

Prodotti verniciati di colore grigio ghisa
Products painted in grey cast iron



2025

Arredo urbano e da giardino
Street and park furniture

86

Linea completa arredo urbano Full catalogue of urban furnishing

www.mcpomicino.it/download/

DOWNLOAD

DISSUASORI

A RICHIESTA E' POSSIBILE DOTARE I
DISSUASORI DI FASCIA RIFRANGENTE



SPHERA Dissuasore stradale, in ghisa, stile SPHERA, di altezza 285 mm dal piano di calpestio e base 150 mm, costituito da un colonnino cavo chiuso alla sommità da una testa sferica e predisposto alla base per l'ancoraggio fisso in fondazione mediante tirafondi.

Cast-iron Bollard, SPHERA style, height 285 mm from the walking surface and a base dimension of 150 mm, consisting of a hollow column closed at the top by a spherical head, preset base for fixed anchoring to foundation with anchor bolts.



Ancoraggio con tirafondi
Anchorage by logbolts

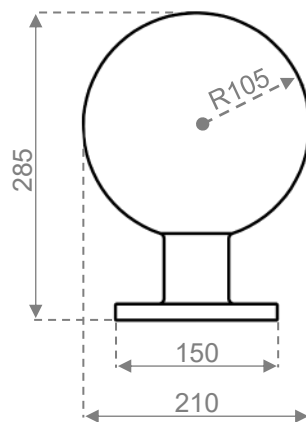

CODICE	ALTEZZA	BASE	PESO TOTALE	NOTE	LISTINO
CODE	HEIGHT	BASE	TOTAL WEIGHT	NOTES	PRICE LIST
	mm	mm	Kg.		€
DISS28	285	Ø 150	11		139,00



DUBLINO Dissuasore stradale in ghisa, stile DUBLINO, di altezza 330mm dal piano di calpestio e base 300 mm, costituito da un colonnino cavo a profilo iperbolico chiuso alla sommità da una testa bombata. Base circolare con apposita zoccolatura per l'ancoraggio fisso in fondazione.

Cast-iron bollard, DUBLINO style, height 330 mm from the walking surface and a base dimension of 300 mm, consisting of an hollow column with hyperbolic section closed at the top with a round head. Circular base with appropriate socles for a fixed anchoring to the foundation.



Ancoraggio fisso in fondazione
Fixed anchorage to the foundation

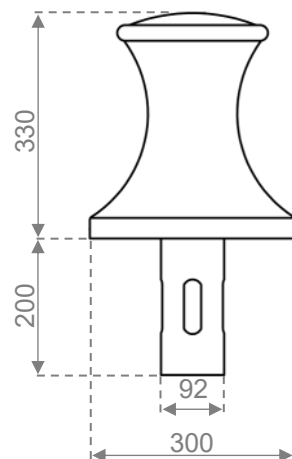

CODICE	ALTEZZA	BASE	PESO TOTALE	NOTE	LISTINO
CODE	HEIGHT	BASE	TOTAL WEIGHT	NOTES	PRICE LIST
	mm	mm	Kg.		€
DISS33	330	Ø 300	23		216,00



OSLO Dissuasore stradale in ghisa, stile OSLO, di altezza 500 mm dal piano di calpestio e base 191 mm, costituito da un colonnino prismatico cavo di sezione e base ottagonale ornata alla sommità da un pomello sferico. Base ottagonale con apposita zoccolatura per l'ancoraggio fisso in fondazione.

Cast-iron Bollard, OSLO style, height 500 mm from the walking surface and a base dimension of 191 mm, consisting of an hollow prismatic column and octagonal base, decorated at the top by a spherical knob. Octagonal base with appropriate socles for a fixed anchoring to the foundation.



Ancoraggio fisso in fondazione
Fixed anchorage to the foundation

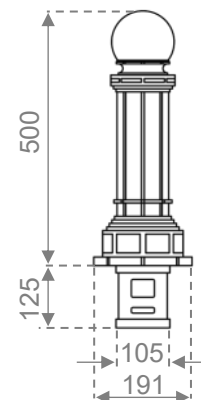

CODICE	ALTEZZA	BASE	PESO TOTALE	NOTE	LISTINO
CODE	HEIGHT	BASE	TOTAL WEIGHT	NOTES	PRICE LIST
	mm	mm	Kg.		€
DISS50T	500	Ø 191	11,5	OCCHIELLI PORTACATENA OPZIONALI EYELETS FOR CHAIN AS OPTIONAL	148,00

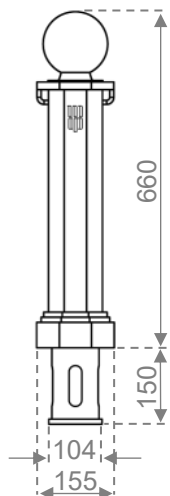

Dissuasore stradale in ghisa, stile NAPOLI, di altezza 660 mm dal piano di calpestio e base 155 mm, costituito da un colonnino prismatico cavo di sezione **NAPOLI** esagonale o ottagonale ornato alla sommità da un pomello sferico e, in opzione, 2 anelli nella parte alta diametralmente opposti per l'eventuale aggancio di catene. Base esagonale o ottagonale con apposita zoccolatura per l'ancoraggio fisso in fondazione.

Cast-iron Bollard, NAPOLI style, height 660 mm from the walking surface and a base dimension of 155 mm, consisting of an hollow prismatic column with hexagonal or octagonal section, decorated at the top by a spherical knob and optionally provided in the upper part by two rings diametrically opposed for the possible hooking of chains. Hexagonal or octagonal base, with appropriate socles for a fixed anchoring to the foundation.

Ancoraggio fisso in fondazione
Anchorage fixed in base



CODICE	ALTEZZA	BASE	PESO TOTALE	NOTE	LISTINO
CODE	HEIGHT	BASE	TOTAL WEIGHT	NOTES	PRICE LIST
	mm	mm	Kg.		€
DISS66T	660	Ø 155	23	OCCHIELLI PORTACATENA OPZIONALI EYELETS FOR CHAIN AS OPTIONAL	227,00

Arredo urbano e da giardino
Street and park furniture

87

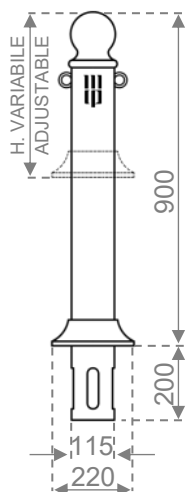

Dissuasore stradale in ghisa, stile GINEVRA, costituito da un colonnino cilindrico cavo, ornato alla sommità da un pomello sferico e, in opzione, nella parte alta da 2 anelli diametralmente opposti per l'eventuale aggancio di catene. Base chiusa da un collarino di ornamento circolare predisposto all'ancoraggio fisso in fondazione mediante apposita zoccolatura.

Cast-iron bollard, GINEVRA style, consisting of an hollow cylindrical column decorated at the top by a spherical knob and optionally provided in the upper part by two rings diametrically opposed for the possible hooking of chains. The base is adorned with a round collar and it has appropriate socles for a fixed anchoring to the foundation.

Ancoraggio fisso in fondazione
Anchorage fixed in base



CODICE	ALTEZZA	BASE	PESO TOTALE	NOTE	LISTINO
CODE	HEIGHT	BASE	TOTAL WEIGHT	NOTES	PRICE LIST
	mm	mm	Kg.		€
DISS90	900	Ø 220	27	OCCHIELLI PORTACATENA OPZIONALI EYELETS FOR CHAIN AS OPTIONAL	400,00

 **COLLARINO MOBILE (ALTEZZA MASSIMA 900 mm F.T.)**
ROUND COLLAR MOVABLE (MAX HEIGHT 900 mm)

Prodotti verniciati di colore grigio ghisa
Products painted in grey cast iron



2025

Arredo urbano e da giardino
Street and park furniture

88

Linea completa arredo urbano Full catalogue of urban furnishing

www.mcpomicino.it/download/

DOWNLOAD

DISSUASORI

A RICHIESTA E' POSSIBILE DOTARE I
DISSUASORI DI FASCIA RIFRANGENTE



MOSCA

Dissuasore stradale in ghisa, stile MOSCA, di altezza 1000 mm dal piano di calpestio, base 200 mm costituito da un colonnino cilindrico cavo con 8 scanalature verticali esterne, ornato alla sommità da una testa di forma sferica e, in opzione, nella parte alta da 2 anelli diametralmente opposti per l'eventuale aggancio di catene e nella parte bassa da decorazioni floreali a calice. Base poligonale con apposita zoccolatura per l'ancoraggio fisso in fondazione.

Cast iron bollard, MOSCA style, height 1000 mm from the walking surface and a base dimension of 200 mm, consisting of a hollow cylindrical column with 8 external vertical grooves; adorned at the top by a head of spherical shape and optionally provided by 2 rings diametrically opposed for the possible chains hooking, and in the lower part by floral decorations. Polygonal base, with appropriate socles for a fixed anchoring to the foundation.



Ancoraggio fisso in fondazione
Fixed anchorage to the foundation

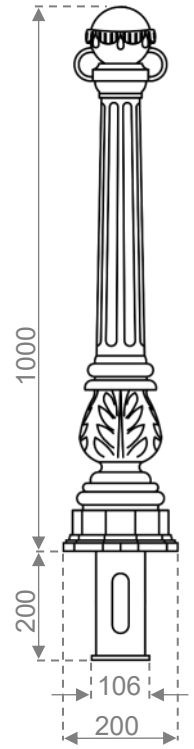

CODICE	ALTEZZA	BASE	PESO TOTALE	NOTE	LISTINO
CODE	HEIGHT	BASE	TOTAL WEIGHT	NOTES	PRICE LIST
	mm	mm	Kg.		€
DISS100	1000	Ø 200	31	OCCHIELLI PORTACATENA OPZIONALI EYELETS FOR CHAIN AS OPTIONAL	459,00



VIENNA

Dissuasore stradale in ghisa, stile VIENNA, di altezza 1100 mm dal piano di calpestio, base Ø 145 mm, costituito da un colonnino cavo a corpo tronco-conico con scanalature verticali esterne e, in opzione, dotato nella parte alta di 2 anelli diametralmente opposti per l'eventuale aggancio di catene. Ornato alla sommità da un pomello sferico sostenuto da un collarino di forma cilindrica. Base circolare con apposita zoccolatura per l'ancoraggio fisso in fondazione.

Cast iron bollard VIENNA style, height 1100 mm from the walking surface, a base of Ø 145 mm, consisting of hollow column with conical frustum shape with the external vertical grooves, decorated at the top by a spherical knob supported by a cylindrical shape collar, and optionally provided by two rings diametrically opposed for the possible hooking of chains. Circular base with appropriate socles for a fixed anchoring to the foundation.



Ancoraggio fisso in fondazione
Fixed anchorage to the foundation

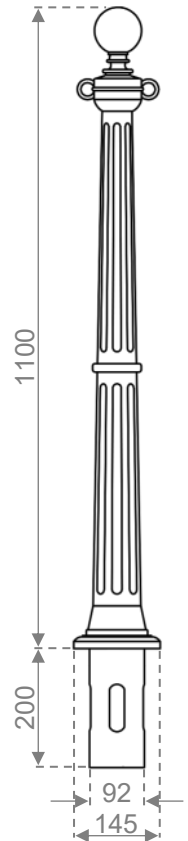

CODICE	ALTEZZA	BASE	PESO TOTALE	NOTE	LISTINO
CODE	HEIGHT	BASE	TOTAL WEIGHT	NOTES	PRICE LIST
	mm	mm	Kg.		€
DISS110	1100	Ø 145	23	OCCHIELLI PORTACATENA OPZIONALI EYELETS FOR CHAIN AS OPTIONAL	340,00

UPON REQUEST IT IS POSSIBLE TO PROVIDE
BOLLARDS WITH REFLECTIVE BANDS

PORTARIFIUTI



2025

Portarifiuti stradale, stile MOSCA, composto da dissuasore in ghisa di altezza 1000 mm dal piano di calpestio, base Ø 200 mm, formato da un colonnino cilindrico cavo con 8 scanalature verticali esterne, ornato alla sommità da una testa di forma sferica e nella parte bassa da decorazioni floreali a calice; base poligonale con apposita zoccolatura per l'ancoraggio fisso in fondazione; cestino in ferro, verniciato a forno con polveri termoindurenti per esterni, ribaltabile ed asportabile da 35 lt diametro 300 mm altezza 530 mm stampato a rilievo ed ornato con due serie di fori, ancorato al colonnino nella parte inferiore mediante un braccio e nella parte superiore tramite un gancio di fermo.

MOSCA

Litter bin, MOSCA style, constituted by cast iron bollard, 1000 mm height from the walking surface, base dimension of 200 mm, consisting of a hollow cylindrical column with 8 external vertical grooves, adorned at the top by a head with a spherical shape, and in the lower part by floral decorations. Polygonal base, with appropriate socles for a fixed anchoring to the foundation. Iron bin, removable and tipping, oven-painted with thermosetting powders for outdoor use, 35 litres capacity, diameter 300 mm, height 530 mm, printed on relief and adorned with two series of holes, anchored to the bollard at the bottom by an arm and by a retaining hook at the top.

Ancoraggio fisso in fondazione
Anchorage fixed in base



CODICE	ALTEZZA	BASE	PESO TOTALE	CAPACITA'	NOTE	LISTINO
CODE	HEIGHT	BASE	TOTAL WEIGHT	CAPACITY	NOTES	PRICE LIST
	mm	mm	Kg.	Lt		€
CEST100/1	1000	Ø 200	38	35	DISS100 + 1 CESTINO	710,00
CEST100/2	1000	Ø 200	45	35 + 35	DISS100 + 2 CESTINI	1.043,00
CEST100/1P	1000	Ø 200	39,5	35	DISS100 + 1CESTINO + 1POSACENERE/S	904,00



Arredo urbano e da giardino
Street and park furniture

89

Portarifiuti stradale, stile VIENNA, composto da dissuasore in ghisa di altezza 1100 mm dal piano di calpestio, base Ø 145 mm, formato da un colonnino cavo a corpo tronco-conico con scanalature verticali esterne, ornato alla sommità da un pomello sferico sostenuto da un collarino di forma cilindrica; base formata da una piastra circolare predisposta all'ancoraggio fisso in fondazione mediante apposita zoccolatura; cestino in ferro, verniciato a forno con polveri termoindurenti per esterni, ribaltabile ed asportabile da 35 lt diametro 300 mm altezza 530 mm stampato a rilievo ed ornato con due serie di fori, ancorato al colonnino nella parte inferiore mediante un braccio ornato e nella parte superiore tramite un gancio di fermo.

VIENNA

Litter bin, VIENNA style, constituted by cast iron bollard, height 1100 mm from the walking surface, base of Ø 145 mm, consisting of hollow column with conical frustum shape with the external vertical grooves, decorated at the top by a spherical knob supported by a cylindrical shape collar. The base is formed by a circular plate with appropriate socles for a fixed anchoring to the foundation. Iron bin, removable and tipping, oven-painted with thermosetting powders for outdoor use, 35 litres capacity, diameter 300 mm, height 530 mm, printed on relief and adorned with two series of holes, anchored to the bollard at the bottom by an arm and by a retaining hook at the top.

Ancoraggio fisso in fondazione
Anchorage fixed in base



CODICE	ALTEZZA	BASE	PESO TOTALE	CAPACITA'	NOTE	LISTINO
CODE	HEIGHT	BASE	TOTAL WEIGHT	CAPACITY	NOTES	PRICE LIST
	mm	mm	Kg.	Lt		€
CEST110/1	1100	Ø 145	30	35	DISS110 + 1 CESTINO	666,00
CEST110/2	1100	Ø 145	37	35 + 35	DISS110 + 2 CESTINI	1.030,00
CEST110/1P	1100	Ø 145	31,5	35	DISS110 + 1CESTINO + 1POSACENERE/S	813,00



MENSOLA A

MENSOLA B

 MENSOLA ALTERNATIVA PER AGGANCIAMENTO CESTINO
ALTERNATIVE BRACKET FOR BINS

Prodotti verniciati di colore grigio ghisa
Products painted in grey cast iron



2025

Arredo urbano e da giardino
Street and park furniture

90

Linea completa arredo urbano Full catalogue of urban furnishing
www.mcpomicino.it/download/

DOWNLOAD

PORTARIFIUTI



MENSOLA A

MENSOLA B

GINEVRA Portarifiuti stradale, stile GINEVRA, composto da dissuasore in ghisa ornato alla sommità da un pomello sferico; base, chiusa da un collarino di ornamento circolare, predisposta all'ancoraggio fisso in fondazione mediante apposita zoccolatura; cestino in ferro, verniciato a forno con polveri termoindurenti per esterni, ribaltabile ed asportabile da 35 lt diametro 300 mm altezza 530 mm stampato a rilievo ed ornato con due serie di fori, ancorato al colonnino nella parte inferiore mediante un braccio e nella parte superiore tramite un gancio di fermo.

Litter bin, GINEVRA style, constituted by cast iron bollard decorated at the top by a spherical knob. The base is closed by an ornamental circular collar, with appropriate socles for a fixed anchoring to the foundation. Iron bin, removable and tipping, oven-painted with thermosetting powders for outdoor use, 35 litres capacity, diameter 300 mm, height 530 mm, printed on relief and adorned with two series of holes, anchored to the bollard at the bottom by an arm and by a retaining hook at the top.

Ancoraggio fisso in fondazione
Fixed anchorage to the foundation

CODICE	ALTEZZA	BASE	PESO TOTALE	CAPACITA'	NOTE	LISTINO
CODE	HEIGHT	BASE	TOTAL WEIGHT	CAPACITY	NOTES	PRICE LIST
	mm	mm	Kg.	Lt		€
CEST90/1	900	Ø 220	34	35	DISS90 + 1 CESTINO	710,00
CEST90/2	900	Ø 220	41	35 + 35	DISS90 + 2 CESTINI	950,00
CEST90/1P	900	Ø 220	35,5	35	DISS90 + 1 CESTINO + 1 POSACENERE/S	811,00

MENSOLA ALTERNATIVA PER AGGANCIAMENTO CESTINO
ALTERNATIVE BRACKET FOR BINS

MARSIGLIA Portarifiuti stradale, in ferro, stile MARSIGLIA, di altezza 1000 mm dal piano di calpestio, base Ø 200 mm, costituito da un colonnino tubolare a forma quadra chiuso alla sommità da una poma sferica e dotato nella parte alta di 1 posacenere a conchiglia; cestino ribaltabile ed asportabile da 35 lt diametro 300 mm altezza 530 mm stampato a rilievo ed ornato con due serie di fori, ancorato al colonnino nella parte inferiore mediante un braccio e nella parte superiore tramite un gancio di fermo. Verniciato a forno con polveri termoindurenti per esterni.

Iron litter bin, MARSIGLIA style, height 1000mm from the walking surface, base Ø 200 mm, consisting of a square shaped tubular column, closed at the top by a spherical pommel and equipped at the upper part with 1 clamshell ashtray. Bin, removable and tipping, 35 litres capacity, diameter 300 mm, height 530 mm, printed on relief and adorned with two series of holes, anchored to the bollard at the bottom by an arm and by retaining hook at the top. Oven-painted with thermosetting powders for outdoor use.

Ancoraggio con tirafondi
Anchorage with logbolts

CODICE	ALTEZZA	BASE	PESO TOTALE	CAPACITA'	NOTE	LISTINO
CODE	HEIGHT	BASE	TOTAL WEIGHT	CAPACITY	NOTES	PRICE LIST
	mm	mm	Kg.	Lt		€
FERCEST100/1P	1000	Ø 200	13	35	1 CESTINO + 1 POSACENERE	545,00

PORTARIFIUTI



2025



FERCEST100/3

Portarifiuti stradale, in ferro, stile **TOLOSA**, di altezza mm 1000 dal piano di calpestio, base Ø mm 200, costituito da un colonnino tubolare chiuso alla sommità da una pomo sferico o da posacenera a conchiglia; cestini ribaltabili ed asportabili da 35 lt diametro 300 mm altezza 530 mm stampati a rilievo ed ornati con due serie di fori, ancorati al colonnino nella parte inferiore mediante un braccio e nella parte superiore tramite un gancio di fermo.

Iron litter bin, TOLOSA style, height 1000 mm from the walking surface, base Ø 200 mm, consisting of tubular column, closed at the top by a spherical pomel or a clamshell ashtray. Iron bin removable tipping bins of 35 litres capacity, diameter 300 mm, height 530 mm, printed on relief and adorned with two series of holes, anchored to the bollard at the bottom by an arm and by retaining hook at the top.



FERCEST100/3P

Ancoraggio con tirafondi
Anchorage with logbolts



CODICE	ALTEZZA	BASE	PESO TOTALE	CAPACITA'	NOTE	LISTINO
CODE	HEIGHT	BASE	TOTAL WEIGHT	CAPACITY	NOTES	PRICE LIST
	mm	mm	Kg.	Lt		€
FERCEST100/3	1000	Ø 200	23	35+35+35	3 CESTINI	998,00
FERCEST100/3P	1000	Ø 200	24	35+35+35	3 CESTINI + 1 POSACENERE/S	1.183,00



SU RICHIESTA VERNICIATURA CON RAL A SCELTA DELL'ACQUIRENTE
PAINTING WITH RAL CHOSEN BY THE CLIENT, UPON REQUEST

Arredo urbano e da giardino
Street and park furniture

91

Portarifiuti stradale, in ferro, stile **PROVENZA**, altezza 1130 mm dal piano di calpestio, costituito da un elemento tubolare in ferro dello spessore di mm 2 sagomato nella parte centrale a formare una curva ad arco e coronato alla sommità da piastra personalizzabile e posacenera a conchiglia. Base ellittica 350x450 mm; cestino ribaltabile ed asportabile da 35 lt diametro 300 mm altezza 530 mm stampato a rilievo ed ornato con due serie di fori, ancorato al colonnino nella parte inferiore mediante un braccio e nella parte superiore tramite due ganci di fermo. Verniciato a forno con polveri termoindurenti per esterni.

Iron litter bin, PROVENZA style, height 1130 mm from walking surface, constituted by a tubular element in iron 2 mm thickness, molded in the central part to form an arc, with a customizable plate and a clamshell ashtray on top. Elliptical base of 350x450 mm. Bin, removable and tipping, 35 litres capacity, diameter 300 mm, height 530 mm, printed on relief and adorned with two series of holes, anchored to the bollard at the bottom by an arm and by 2 retaining hooks at the top. Oven-painted with thermosetting powders for outdoor use.

Area personalizzabile
Customizable area



Ancoraggio con tirafondi
Anchorage with logbolts



CODICE	ALTEZZA	BASE	PESO TOTALE	CAPACITA'	NOTE	LISTINO
CODE	HEIGHT	BASE	TOTAL WEIGHT	CAPACITY	NOTES	PRICE LIST
	mm	mm	Kg.	Lt		€
FERCEST113	1130	350X450	17	35		880,00



SU RICHIESTA PERSONALIZZAZIONE DELL'AREA INDICATA CON SUPPLEMENTO DI PREZZO
CUSTOMIZATION OF THE INDICATED AREA, UPON REQUEST WITH SURCHARGE

Prodotti verniciati di colore grigio ghisa
Products painted in grey cast iron



2025

Arredo urbano e da giardino
Street and park furniture

92

Linea completa arredo urbano Full catalogue of urban furnishing
www.mcpomicino.it/download/

DOWNLOAD

PORTARIFIUTI



CESTDOG/2

DOGTOILET Contenitore stradale per la raccolta di deiezioni animali, stile DOGTOILET, altezza dal piano di calpestio 1180 mm, costituito da un elemento tubolare in ferro (Ø 48 mm) sagomato agli angoli e con basi circolari provviste di fori per l'ancoraggio al suolo mediante tirafondi. Contenitore in lamiera zincata, vincolato al supporto tubolare, provvisto di coperchio superiore basculante per l'accesso al cestino interno in lamiera zincata, sportello frontale basculante con doppia chiusura per l'estrazione del cestino di raccolta.

Street container for the collection animal waste, DOGTOILET Style, height 1180 mm from walking surface, consisting of a tubular iron element (Ø 48 mm) shaped at the corners and with circular bases provided with holes for anchoring to the ground by means of log bolts. Galvanized sheet container, bound to the tubular support, equipped with a tilting top cover for access to the internal galvanized sheet bin, tilting front door with double closure for extracting the waste bin.



Ancoraggio con tirafondi

Anchorage with logbolts



CESTDOG/1

CODICE	ALTEZZA	BASE	PESO TOTALE	CAPACITA'	NOTE	LISTINO
CODE	HEIGHT	BASE	TOTAL WEIGHT	CAPACITY	NOTES	PRICE LIST
	mm	mm	Kg.	Lt		€
CESTDOG/1	1180	150X570		18	GRIGIO / VERDE GREY / GREEN	801,00
CESTDOG/2	1800	150X570		18	GRIGIO / VERDE GREY / GREEN	1.294,00

CON DISPENSER SACCHETTI IGIENICI
HYGIENE BAG DISPENSER

PORTABICI



PORTABICI/754



PORTABICI

CODICE	LUNGHEZZA	LARGHEZZA	ALTEZZA	NOTE	LISTINO
CODE	LENGHT	WIDTH	HEIGHT	NOTES	PRICE LIST
	mm	mm	mm		€
PORTABICI	1560	420	230	ANCORAGGIO CON TIRAFONDI ANCHORAGE BY LOGBOLTS	1.331,00
PORTABICI/754	1600	-	600	ANCORAGGIO CON TIRAFONDI ANCHORAGE BY LOGBOLTS	1.479,00
PORTABICI/753	1600	-	600	ANCORAGGIO FISSO IN FONDAZIONE FIXED ANCHORAGE TO THE FOUNDATION	1.479,00

ACCESSORI



2025



CODICE CODE	ALTEZZA HEIGHT mm	BASE BASE mm	PESO TOTALE TOTAL WEIGHT Kg.	CAPACITA' CAPACITY Lt	NOTE NOTES	LISTINO PRICE LIST €
CESTINO	530	Ø 350	5	35	SINGOLO SINGLE BINS	222,00
CESTINO/PAR	530	Ø 350	7	35	CESTINO CON STAFFA A PARETE BINS WITH WALL BRACKET	348,00
POSACENERE/S	200	Ø 200	1,5	0,5	IDONEO PER DISS110, DISS100, DISS86/C, DISS90 E DISS112 SUITABLE FOR DISS110, DISS100, DISS86/C, DISS90 AND DISS112	156,00



CATENA
CHAIN

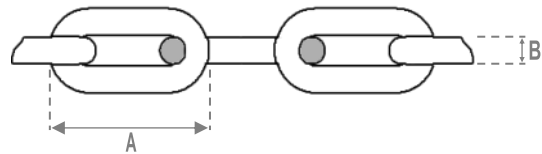

93

CODICE CODE	PASSO (A) PICHT (A) mm	DN (B) ND (B) mm	PESO WEIGHT Kg.	LUNGHEZZA LENGTH mt	NOTE NOTES	LISTINO PRICE LIST €	
CTN60	i	42	6	6,3	10	IL PREZZO E IL PESO SI RIFERISCE AL KIT DI 10 METRI LINEARI THE PRICE AND WEIGHT REFER TO KIT OF 10 LINEAR METERS	171,00
CTN60/G	ii	42	6	24	30	IL PREZZO E IL PESO SI RIFERISCE AL KIT DI 30 METRI LINEARI THE PRICE AND WEIGHT REFER TO KIT OF 30 LINEAR METERS	1.232,00
CTN60/GANC/Z	i		6			GANCIO (MAGLIA OVALE) OVAL QUICK LINK	13,00
CTN60/GANC	ii		6			GANCIO (MAGLIA OVALE) OVAL QUICK LINK	13,00



IN ACCIAIO ZINCATO (NON VERNICIATA)
GALVANIZED STEEL (UNPAINTED)



MICALIZZATA GRIGIA
GREY MICA PAINT

Esempi di composizioni
Some Examples



CEST100/1P



CEST100/2

Prodotti verniciati di colore grigio ghisa
Products painted in grey cast iron

PALINA PUBBLICITARIA

BUDAPEST

Palina pubblicitaria in ferro e ghisa, stile BUDAPEST, costituita da tabella a doppia riquadratura sovrapposta con pannello centrale, zincata a caldo, a supporto del materiale pubblicitario, fregio ornamentale inferiore in ghisa per il collegamento al palo di sostegno in ferro zincato a caldo (ø 76 mm), predisposto all'ancoraggio fisso in fondazione, chiuso alla base da un collarino di ornamento circolare.

Iron and Cast iron advertising pole, BUDAPEST style, consisting of a hot zined double superimposed framed panel for the support of the central advertising billboard,

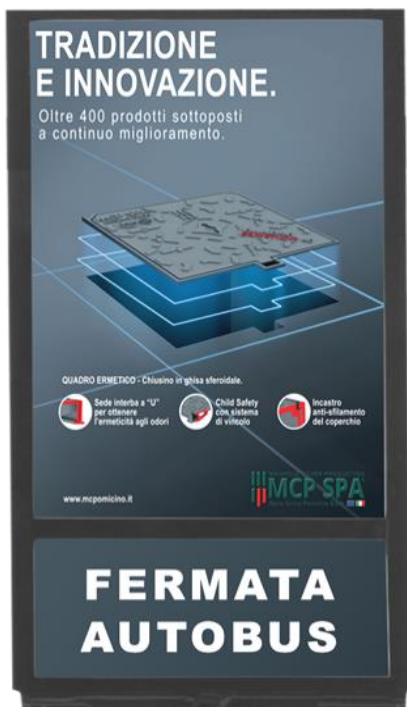

cast iron ornamental junction to the sustaining hot zined iron pole (ø 76 mm), pre-set for the anchoring to the foundation, closed at the base by an ornamental circular collar.

INS/467



INS/468

CRACOVIA

Palina pubblicitaria in ferro e ghisa, stile CRACOVIA, costituita da tabella in ferro, zincata a caldo, con pannello centrale a supporto del materiale pubblicitario, collegata al palo di sostegno in ferro zincato a caldo (ø 60 mm nella parte superiore e ø 76mm nella parte inferiore) sagomato ad arco nella parte superiore, a cornice di una piastra semicircolare personalizzabile, e chiuso alla base, predisposta per l'ancoraggio fisso in fondazione, da collarino di ornamento circolare.

Iron and Cast iron advertising pole, CRACOVIA style, consisting of an iron hot zined panel for the support of the central advertising billboard, jointed to the sustaining hot zined iron pole, (ø 60mm in the upper part and ø 76 mm in the lower one), arc shaped in the upper part framing a customizable semi-circular plate, closed at the base, pre-set for the anchoring to the foundation, by an ornamental circular collar .

CODICE	ALTEZZA	LARGHEZZA	PESO TOTALE	NOTE	LISTINO
CODE	HEIGHT	WIDTH	TOTAL WEIGHT	NOTES	PRICE LIST
	mm	mm	Kg.		€
INS/467	2900	700	-	ANCORAGGIO FISSO IN FONDAZIONE FIXED ANCHORAGE TO THE FOUNDATION	1.331,00
INS/468	3000	880	-	ANCORAGGIO FISSO IN FONDAZIONE FIXED ANCHORAGE TO THE FOUNDATION	1.725,00



TABELLA NON INCLUSA
BOARD NOT INCLUDED

Transenna in ghisa, stile **VARSAVIA**, altezza 1080 mm dal piano di calpestio, costituita da 2 paletti tubolari (diametro 60 mm) ornati alla sommità da pomo sferico, basi chiuse da collarini di ornamento circolari in ghisa, telaio portainsegna in tubolari di ferro (dim. est. 1000x700 mm) provvisto di attacchi per l'aggancio ai paletti laterali.

Cast iron barrier, VARSAVIA Style, height 1080 mm from walking surface, consisting by 2 tubular bollards (diameter 60 mm), decorated at the top by a spherical knob, bases made by ornamental collars in cast iron fixed to the poles, sign holder frame consisting of iron tubulars (ext. dim. 1000x700 mm) provided with housing joints to the bollards.



CODICE	ALTEZZA	LARGHEZZA	PESO TOTALE	NOTE	LISTINO
CODE	HEIGHT	WIDTH	TOTAL WEIGHT	NOTES	PRICE LIST
	mm	mm	Kg.		€
TRAN/532	1080	1350	-	ANCORAGGIO FISSO IN FONDAZIONE FIXED ANCHORAGE TO THE FOUNDATION	1.183,00
TRAN/533	1080	1350	-	ANCORAGGIO CON TIRAFONDI ANCORAGE WITH LOGBOLTS	1.183,00



TABELLA NON INCLUSA
BOARD NOT INCLUDED

Transenna in ferro zincato non verniciato stile **LIONE**, costituita da un elemento tubolare in ferro dello spessore di 2 mm sagomato nella parte centrale a formare una curva ad arco di altezza 1000 mm dal piano di calpestio. Ancoraggio fisso in fondazione mediante apposita zoccolatura.

Galvanized iron barrier, unpainted, LIONE style, constituted by a tubular element in iron thickness of 2 mm, molded in the central part to form an arc, of height 1000 mm from the walking surface. Fixed anchorage to the foundation through appropriate socles.



Ancoraggio fisso in fondazione
Fixed anchorage to the foundation

CODICE	ALTEZZA DA TERRA	ALTEZZA TOTALE	LARGHEZZA INTERNA	LARGHEZZA TOTALE	PESO TOTALE	DIAMENSIONI TUBOLARE	LISTINO
CODE	HEIGHT	TOTAL HEIGHT	INTERNAL WIDTH	TOTAL WIDTH	TOTAL WEIGHT	TUBULAR DIMENSION	PRICE LIST
	mm	mm	mm	mm	Kg.	mm	€
TRANSFER35	1000	1200	250	350	6	Ø 48	172,00
TRANSFER85	1000	1200	754	850	8	Ø 48	217,00
TRANSFER55/60	1000	1200	430	550		Ø 60	298,00
TRANSFER85/60	1000	1200	730	850		Ø 60	326,00



SU RICHIESTA BARRA ORIZZONTALE INTERMEDIA CON SUPPLEMENTO DI PREZZO
HORIZONTAL INTERMEDIATE BAR UPON REQUEST, WITH SURCHARGE
SU RICHIESTA SI EFFETTUA VERNICIATURA CON SUPPLEMENTO DI PREZZO
PAINTING UPON REQUEST, WITH SURCHARGE

ILLUMINAZIONE PALI

BERLINO Pali per lampioni in ghisa e ferro, stile BERLINO, costituito da base in fusione di ghisa a rilievo ornamentale, con portello di accesso per l'ispezione interna per i modelli provvisti di conchiglia passacavi, elementi sovrapposti in fusione di ghisa, con diametri esterni a scalare, alternati con collarini/riduzioni circolari a chiusura delle rastremazioni innestati su tubo in ferro zincato per il montaggio della cima/lanterna di illuminazione opzionale.

Iron and cast-iron lamppost poles, BERLINO style, consisting of a cast iron base with ornamental relief and with access door for internal inspection on models equipped with internal cable box; overlapping elements in cast iron with external scalar diameters, alternating with collars or circular reductions closing the taperings. All elements are grafted on the internal zincated iron pole for the fixing of the optional upper lighting lantern.

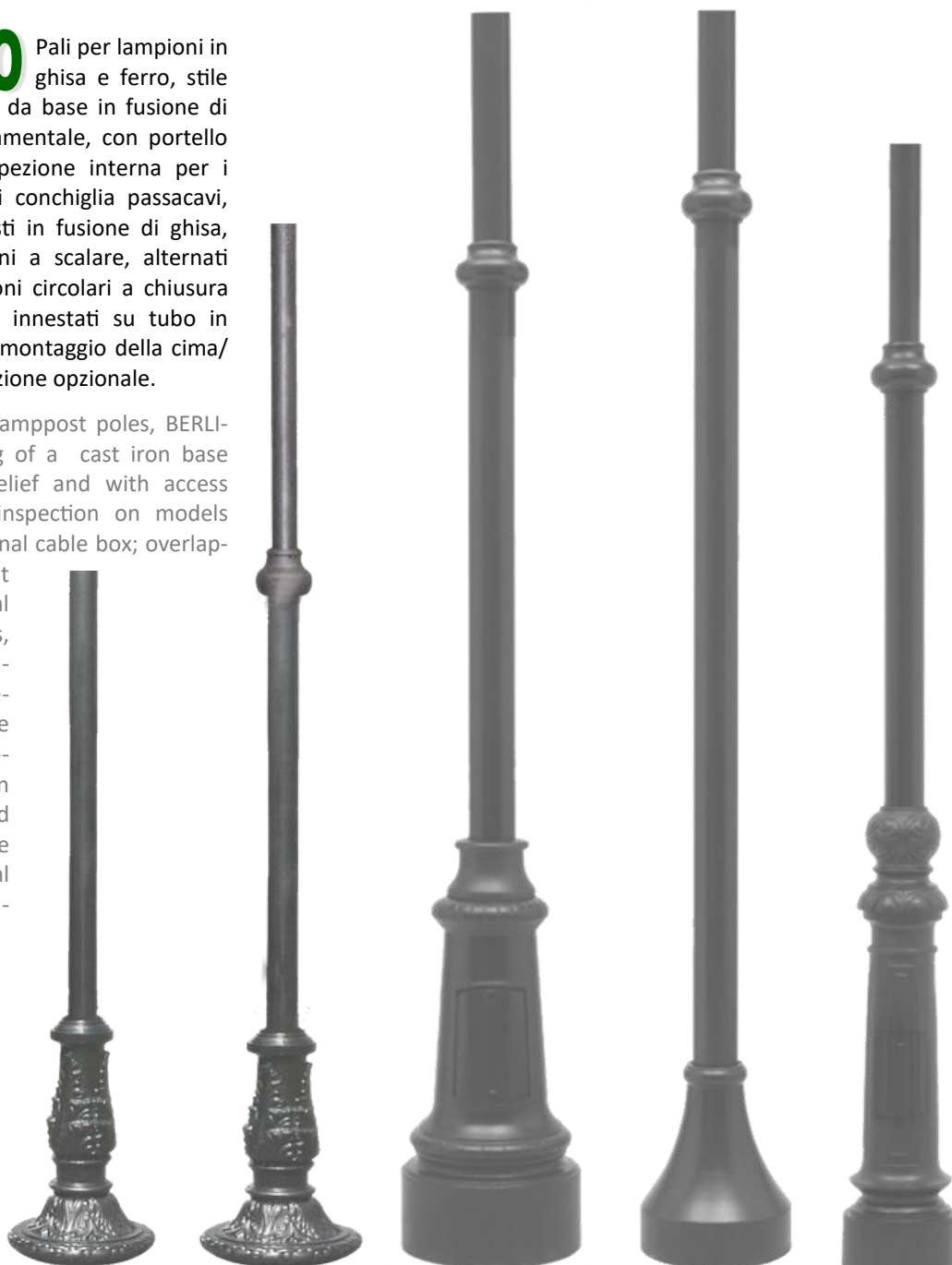

LAMP/2000

LAMP/3500

LAMP/321

LAMP/324

LAMP/330

CODICE	ALTEZZA	BASE	PESO TOTALE	NOTE	LISTINO
CODE	HEIGHT	BASE	TOTAL WEIGHT	NOTES	PRICE LIST
	mm	mm	Kg.		€
LAMP/2000	2000	Ø 300		FISSAGGIO A MEZZO FLANGIA IN FERRO FIXING BY STEEL FLANGE	1.282,00
LAMP/3500	3500	Ø 300		FISSAGGIO A MEZZO FLANGIA IN FERRO FIXING BY STEEL FLANGE	1.479,00
LAMP/321 <i>i</i>	6000	Ø 350		ANCORAGGIO FISSO IN FONDAZIONE DI ALMENO 80 cm. FIXED ANCHORAGE TO THE FOUNDATION OF AT LEAST 80 cm.	1.774,00
LAMP/324 <i>i</i>	6000	Ø 270		ANCORAGGIO FISSO IN FONDAZIONE DI ALMENO 80 cm. FIXED ANCHORAGE TO THE FOUNDATION OF AT LEAST 80 cm.	1.676,00
LAMP/330 <i>i</i>	3000	Ø 250		ANCORAGGIO FISSO IN FONDAZIONE DI ALMENO 80 cm. FIXED ANCHORAGE TO THE FOUNDATION OF AT LEAST 80 cm.	1.380,00



CON CONCHIGLIA PER ISPEZIONE
WITH INSPECTABLE CABLE BOX

POSSIBILITA', SU RICHIESTA, DI DOTARE I PALI CON 2 O 3 BRACCI
POSSIBILITY TO EQUIP THE CAST-IRON LAMPS WITH OF 2 OR 3 ARMS

ILLUMINAZIONE BRACCI A MURO



2025



LUX/414



LUX/415

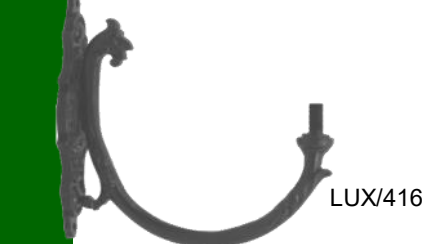

LUX/416



LUX/410A

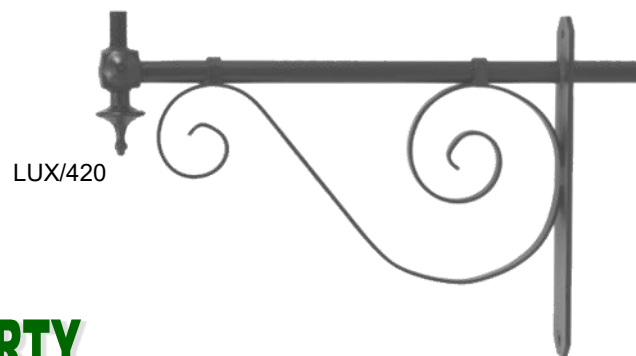

LUX/420

LIBERTY

CODICE	SPORGENZA	PESO TOTALE	NOTE	LISTINO
CODE	PROJECTION	TOTAL WEIGHT	NOTES	PRICE LIST
	mm	Kg.		€
LUX/410	700			715,00
LUX/410A	750		A SOSPENSIONE SUSPENDED LAMP	715,00
LUX/414	700			1.065,00
LUX/415	500			646,00
LUX/416	500			572,00
LUX/420	800			607,00
LUX/420A	900		A SOSPENSIONE SUSPENDED LAMP	607,00

Arredo urbano e da giardino
Street and park furniture

97



LANT/1104



LANT/1115



LANT/1117



LANT/1118

LANTERNE

CODICE	ALTEZZA LANTERNA	LARGHEZZA LANTERNA	PESO TOTALE	NOTE	LISTINO
CODE	LANTERN HEIGHT	LANTERN WIDTH	TOTAL WEIGHT	NOTES	PRICE LIST
	mm	mm	Kg.		€
LANT/1104	780	450X450		ESCLUSO CORPO ILLUMINANTE LIGHTING FIXTURE EXCLUDED	986,00
LANT/1115	640	350X350		ESCLUSO CORPO ILLUMINANTE LIGHTING FIXTURE EXCLUDED	518,00
LANT/1117	470	285X285		ESCLUSO CORPO ILLUMINANTE LIGHTING FIXTURE EXCLUDED	375,00
LANT/1118	600	Ø 500		INCLUSO CORPO ILLUMINANTE A LED DA 40 Watt 40 W LED LIGHTING FIXTURE INCLUDED	1.873,00
COD.1250		CORPO ILLUMINANTE LIGHTING FIXTURE		PIASTRA A LED 30 Watt 30 W LED PLATE	853,00
COD.1251		CORPO ILLUMINANTE LIGHTING FIXTURE		PIASTRA A LED 40 Watt 40 W LED PLATE	853,00
COD.1252		CORPO ILLUMINANTE LIGHTING FIXTURE		PIASTRA A LED 60 Watt 60 W LED PLATE	927,00
COD.1253		CORPO ILLUMINANTE LIGHTING FIXTURE		PIASTRA A LED 90 Watt 90 W LED PLATE	1.420,00

LA GAMMA COMPLETA DI LAMPIONI E' SCARICABILE DAL NOSTRO SITO
THE FULL RANGE OF LAMP POSTS CAN BE DOWNLOADED FROM OUR WEBSITE

Prodotti verniciati di colore grigio ghisa
Products painted in grey cast iron



2025

Arredo urbano e da giardino
Street and park furniture

98

Linea completa arredo urbano Full catalogue of urban furnishing

www.mcpomicino.it/download/

↓ DOWNLOAD

FIORIERE



SIVIGLIA Fioriera in ghisa in fusione unica, stile SIVIGLIA, costituita da un elemento concavo liscio dotato di foro centrale per l'opportuno deflusso dei liquidi e di una base per l'appoggio al suolo.

Cast-iron flower pot, SIVIGLIA style, made of a single casting, consisting of a smooth concave element provided with a central hole for appropriate outflow of liquids and base as ground support.

CODICE	DIM. ESTERNE	DIM. INTERNE	ALTEZZA	PESO TOTALE	NOTE	LISTINO
CODE	EXTERNAL DIMENSION	INTERNAL DIMENSION	HEIGHT	TOTAL WEIGHT	NOTES	PRICE LIST
	mm	mm	mm	Kg.		€
FLOW1/S	Ø 900	Ø 750	550	130	CON BASE DIM. Ø 500 mm WITH BASE DIM. Ø 500 mm	2.691,00
FLOW1/L	Ø 1100	Ø 1000	550	180	CON BASE DIM. Ø 600 mm WITH BASE DIM. Ø 600 mm	3.726,00

BARCELLONA Fioriera in ghisa, stile BARCELLONA, costituita da un elemento concavo a rilievi concentrici decrescenti dotata di foro centrale per l'opportuno deflusso dei liquidi e sostenuta da 3 piedi di forma sferica per l'appoggio al suolo.

Cast-iron flower pot, BARCELLONA style, constituted by a concave element with concentric decreasing reliefs; with central hole for appropriate outflow of liquids and supported by three spherical feet as ground support.



CODICE	DIM. ESTERNE	DIM. INTERNE	ALTEZZA	PESO TOTALE	NOTE	LISTINO
CODE	EXTERNAL DIMENSION	INTERNAL DIMENSION	HEIGHT	TOTAL WEIGHT	NOTES	PRICE LIST
	mm	mm	mm	Kg.		€
FLOW2/S	Ø 900	Ø 750	385	115	APPOGGIO SU 3 SFERE BASE BY 3 SPHERICAL FEET	2.380,00
FLOW2/L	Ø 1350	Ø 1100	700	210	APPOGGIO SU 3 SFERE BASE BY 3 SPHERICAL FEET	4.346,00

STRASBURGO

Fioriera in ferro, stile STRASBURGO, costituita da contenitore quadrato, in lamiera di ferro zincata e verniciata a caldo, provvista di foro centrale per l'opportuno deflusso e sostenuta da 4 paletti agli angoli in tubolare di ferro a forma quadrata zincati e verniciati a caldo e chiusi alla sommità da pomo sferico, bordo superiore anch'esso in tubolare di ferro zincato e verniciato a caldo, elemento ornamentale sui lati esterni.

Iron flower pot, STRASBURGO style, consisting of a square container made of zincated and hot painted sheet iron provided with a central draining hole, with 4 square shaped iron tubular poles zincated and hot painted closed at the top with a spherical knob, and positioned at the corners. Top edge consisting of square shaped iron tubular zincated and hot painted. Ornamental element on external sides.



CODICE	DIM. ESTERNE	DIM. INTERNE	ALTEZZA	PESO TOTALE	NOTE	LISTINO
CODE	EXTERNAL DIMENSION	INTERNAL DIMENSION	HEIGHT	TOTAL WEIGHT	NOTES	PRICE LIST
	mm	mm	mm	Kg.		€
FLOW3/Q	420X420	350X350	450	16		631,00

AMSTERDAM

Fioriera in ferro, stile AMSTERDAM, costituita da contenitore rettangolare, in lamiera di ferro zincata e verniciata a caldo, provvista di foro centrale per l'opportuno deflusso dei liquidi e sostenuta da 4 paletti agli angoli in tubolare di ferro a forma quadrata zincati e verniciati a caldo e chiusi alla sommità da pomo sferico, bordo superiore anch'esso in tubolare di ferro zincato e verniciato a caldo, elemento ornamentale sui lati esterni.

Iron flower pot, AMSTERDAM style, consisting of a rectangular container made of zincated and hot painted sheet iron provided with a central draining hole, with 4 square shaped iron tubular poles zincated and hot painted closed at the top with a spherical knob, and positioned at the corners. Top edge consisting of square shaped iron tubular zincated and hot painted. Ornamental element on external sides.



CODICE	DIM. ESTERNE	DIM. INTERNE	ALTEZZA	PESO TOTALE	NOTE	LISTINO
CODE	EXTERNAL DIMENSION	INTERNAL DIMENSION	HEIGHT	TOTAL WEIGHT	NOTES	PRICE LIST
	mm	mm	mm	Kg.		€
FLOW3/R	380X1080	300X1000	450	26		833,00



2025

Arredo urbano e da giardino
Street and park furniture

100

Linea completa arredo urbano Full catalogue of urban furnishing

www.mcpomicino.it/download/

DOWNLOAD

GRIGLIE PER ALBERI CONCENTRICHE LONDRA

ALBCONC10/C - ALBCONC15/C - ALBCONC20/C

Griglia per alberi in ghisa, stile LONDRA, di forma circolare con una fila di asole posizionate a raggiera e fori disposti su 2 cerchi concentrici lungo i bordi perimetrali, costituita da 4 elementi componibili uniti mediante staffe bullonate alloggiati in apposite sedi.

Cast-iron tree grating, LONDRA style, round shaped with radial slots and holes located on 2 concentric circles along the perimetral edge, consisting of 4 modular elements assembled with brackets and bolts inserted in the proper housings.

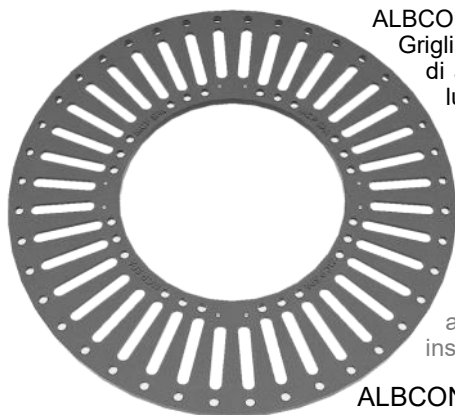

ALBCONC10/C

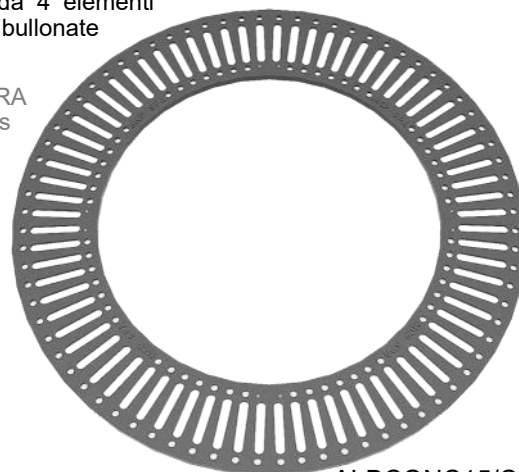

ALBCONC15/C

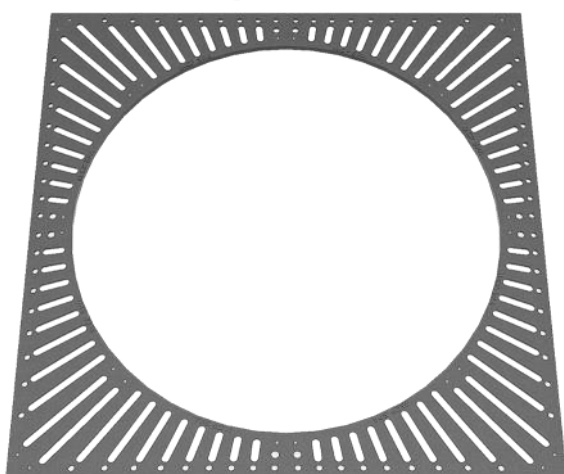

ALBCONC18

ALBCONC18 - ALBCONC20

Griglia per alberi in ghisa, stile LONDRA, di forma quadra con asole disposte a raggiera e ulteriori fori disposti lungo il bordo perimetrale, costituita da 8 elementi componibili uniti mediante staffe bullonate alloggiati in apposite sedi.

Cast-iron tree grating, LONDRA style, square shaped with radial slots and additional holes located along the perimetral edge, consisting of 8 modular elements assembled with brackets and bolts inserted in the proper housings.

Possibilità di montaggio delle griglie in combinazione tra loro a formare un unico elemento di forma esterna quadra/circolare con dimensione interna variabile.

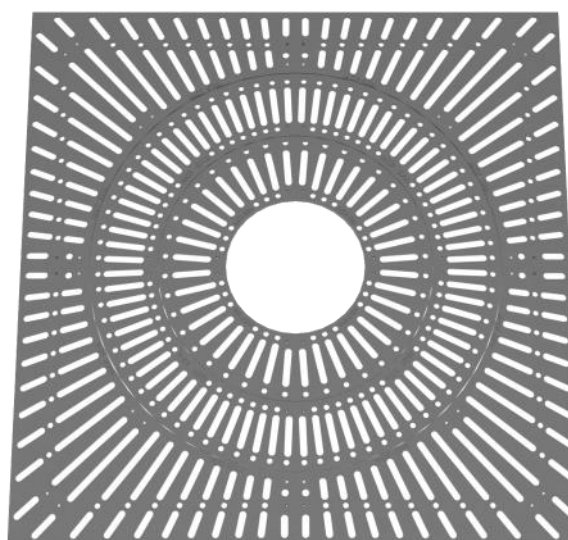

ALBCONC10/C + ALBCONC15/C + ALBCONC20

Possibility of assembling the grids in combination between them to form a single element of square or circular external shape and variable internal dimension.

CODICE	DIM. ESTERNE	DIM. INTERNE	ALTEZZA	PESO TOTALE	NOTE	LISTINO
CODE	EXTERNAL DIMENSION	INTERNAL DIMENSION	HEIGHT	TOTAL WEIGHT	NOTES	PRICE LIST
	mm	mm	mm	Kg.		€
ALBCONC10/C	Ø 1000	Ø 564	25	40	4 PEZZI CADAUNA 4 PIECES EACH	597,00
ALBCONC15/C	Ø 1500	Ø 1004	25	68	4 PEZZI CADAUNA 4 PIECES EACH	1.014,00
ALBCONC18	1800X1800	Ø 1504	25	96	8 PEZZI CADAUNA 8 PIECES EACH	1.432,00
ALBCONC20/C	Ø 1990	Ø 1504	25	104	8 PEZZI CADAUNA 8 PIECES EACH	1.551,00
ALBCONC20	2000X2000	Ø 1504	25	160	8 PEZZI CADAUNA 8 PIECES EACH	2.386,00

TELAJ IN FERRO

ALBCONC10/C/T	Ø 1010	Ø 1000	30	IDONEO PER ALBCONC10/C SUITABLE FOR TREE GRATING ALBCONC10/C	345,00
ALBCONC15/C/T	Ø 1510	Ø 1500	30	IDONEO PER ALBCONC15/C SUITABLE FOR TREE GRATING ALBCONC15/C	469,00
ALBCONC18/T	1810X1810	1800X1800	30	IDONEO PER ALBCONC18 SUITABLE FOR TREE GRATING ALBCONC18	419,00
ALBCONC20/C/T	Ø 2000	Ø 1990	30	IDONEO PER ALBCONC20/C SUITABLE FOR TREE GRATING ALBCONC20/C	592,00
ALBCONC20/T	2010X2010	2000X2000	30	IDONEO PER ALBCONC20 SUITABLE FOR TREE GRATING ALBCONC20	542,00

GRIGLIE PER ALBERI



2025

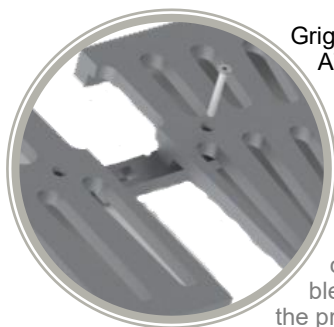

Griglia per alberi in ghisa, stile **ATENE**, di forma quadrata con asole disposte su 3 circonferenze concentriche costituita da 4 elementi componibili uniti mediante staffe bullonate di ghisa alloggiati in apposite sedi.

Cast-iron tree grate, ATENE style, square shaped, with slots located on 3 concentric circles, formed by four modular elements assembled with cast iron brackets and bolts inserted in the proper housings.

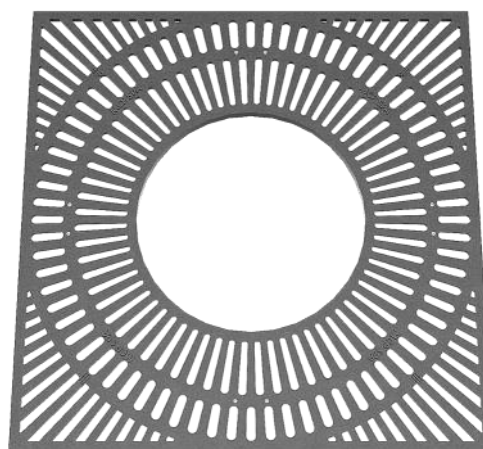

PARIGI

Griglia per alberi in ghisa, stile **PARIGI**, di forma circolare con asole disposte su 2 circonferenze concentriche costituita da 4 elementi componibili uniti mediante staffe bullonate di ghisa alloggiati in apposite sedi.

Cast-iron tree grate, PARIGI style, circular shaped, with slots located on 2 concentric circles, consisting of 4 modular elements assembled with cast-iron brackets and bolts inserted in the proper housings.

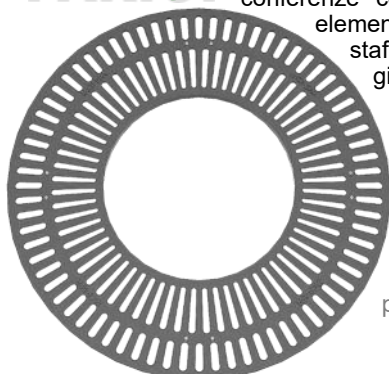

ALBQ10/ES

CODICE	DIM. ESTERNE	DIM. INTERNE	ALTEZZA	PESO TOTALE	NOTE	LISTINO
CODE	EXTERNAL DIMENSION	INTERNAL DIMENSION	HEIGHT	TOTAL WEIGHT	NOTES	PRICE LIST
	mm	mm	mm	Kg.		€

ATENE

ALBQ6	600X600	Ø 300	24	27	2 PEZZI CADAUNA 2 PIECES EACH	533,00
ALBQ8	800X800	Ø 400	24	31	4 PEZZI CADAUNA 4 PIECES EACH	459,00
ALBQ10	1000X1000	Ø 500	24	50	4 PEZZI CADAUNA 4 PIECES EACH	740,00
ALBQ12	1200X1200	Ø 600	26	77	4 PEZZI CADAUNA 4 PIECES EACH	1.139,00

PARIGI

ALBC6	Ø 600	Ø 300	24	19	2 PEZZI CADAUNA 2 PIECES EACH	515,00
ALBC8	Ø 800	Ø 400	24	23	4 PEZZI CADAUNA 4 PIECES EACH	340,00
ALBC10	Ø 1000	Ø 500	24	37	4 PEZZI CADAUNA 4 PIECES EACH	547,00
ALBC12	Ø 1200	Ø 600	26	65	4 PEZZI CADAUNA 4 PIECES EACH	961,00

ESTENSIONE

ALBQ10/ES	260X250		24	5	IDONEI PER ALBQ10 E ALBC10 SUITABLE FOR TREE GRATING ALBQ10 AND ALBC10	87,00
-----------	---------	--	----	---	---	-------

TELAI IN FERRO

ALBQ6/T	610X610	600X600	30		IDONEO PER ALBQ6 SUITABLE FOR TREE GRATING ALBQ6	173,00
ALBQ8/T	810X810	800X800	30		IDONEO PER ALBQ8 SUITABLE FOR TREE GRATING ALBQ8	198,00
ALBQ10/T	1010X1010	1000X1000	30		IDONEO PER ALBQ10 SUITABLE FOR TREE GRATING ALBQ10	222,00
ALBQ12/T	1210X1210	1200X1200	30		IDONEO PER ALBQ12 SUITABLE FOR TREE GRATING ALBQ12	247,00
ALBC6/T	Ø 610	Ø 600	30		IDONEO PER ALBC6 SUITABLE FOR TREE GRATING ALBC6	247,00
ALBC8/T	Ø 810	Ø 800	30		IDONEO PER ALBC8 SUITABLE FOR TREE GRATING ALBC8	271,00
ALBC10/T	Ø 1010	Ø 1000	30		IDONEO PER ALBC10 SUITABLE FOR TREE GRATING ALBC10	296,00
ALBC12/T	Ø 1210	Ø 1200	30		IDONEO PER ALBC12 SUITABLE FOR TREE GRATING ALBC12	321,00

Arredo urbano e da giardino
Street and park furniture

101

Prodotti verniciati di colore grigio ghisa
Products painted in grey cast iron



2025

Arredo urbano e da giardino
Street and park furniture

102

Full catalogue of urban furnishing

www.mcpomicino.it/download/

Linea completa arredo urbano



GRIGLIE PER ALBERI MODULARE

TRIESTE Griglia per alberi in ghisa, stile TRIESTE, di forma, dimensioni esterne e dimensioni interne variabili, costituita da elementi unitari di forma triangolare (320x320x450 mm) componibili mediante staffe bullonate di ghisa poste sul lato inferiore. La geometria e le dimensioni delle griglie riproducibili sono varie e modulari.

Cast iron tree grate, Trieste style, of variable shape, internal and external dimensions, consisting of unitary elements of triangular shape (320x320x450 mm) assembled with cast iron brackets and bolts on the underside. The geometry and dimensions of reproducible grates are varied and modular.



ALBT45

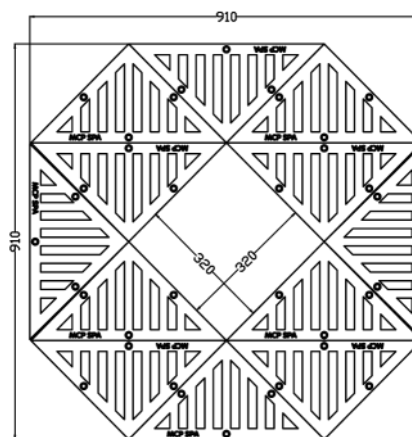
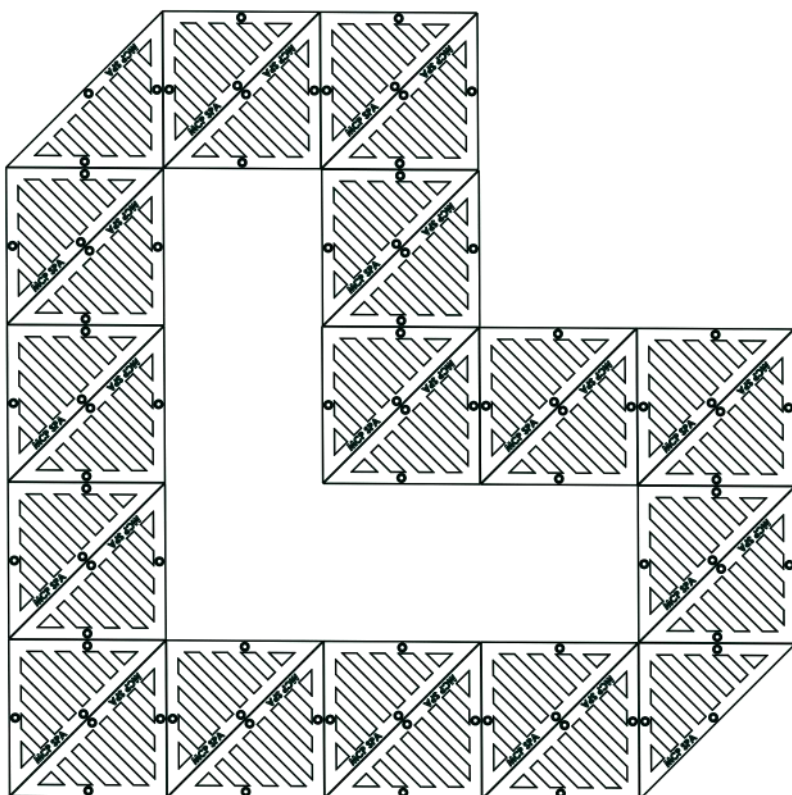

GRIGLIA OTTAGONALE
OCTAGONAL GRATING

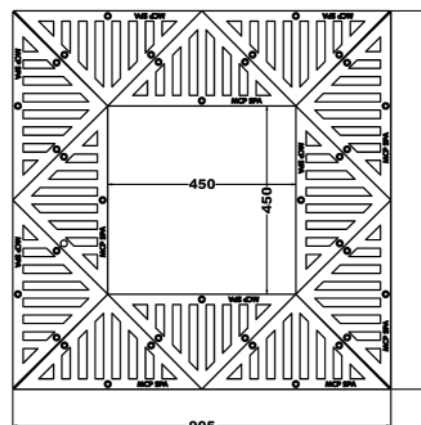

GRIGLIA QUADRA
SQUARE GRATING

La griglia modulare TRIESTE è stata realizzata per soddisfare varie esigenze di lunghezza e forma.



The TRIESTE modular grating was created to meet various length and shape needs.

CODICE	DIM. ESTERNE	DIM. INTERNE	ALTEZZA	PESO TOTALE	NOTE	LISTINO
CODE	EXTERNAL DIMENSION	INTERNAL DIMENSION	HEIGHT	TOTAL WEIGHT	NOTES	PRICE LIST
	mm	mm	mm	Kg.		€
ALBT45	320X320X450		25	7	1 PEZZO 1 PIECE	42,00

ALCUNI ESEMPI / SOME EXAMPLES

12 PZ/PCS ALBT45	905X905	450X450	25	7X12=84	GRIGLIA QUADRA SQUARE GRATING	504,00
16 PZ/PCS ALBT45	1355X905	900X450	25	7X16=112	GRIGLIA RETTANGOLARE RECTANGULAR GRATING	672,00
12 PZ/PCS ALBT45	910X910	320X320	25	7X12=84	GRIGLIA OTTAGONALE OCTAGONAL GRATING	504,00

GRIGLIE PER ALBERI



2025

Griglia modulare per alberi in ghisa, stile **KJA**, di forma quadra, costituita da 4 elementi a "L" componibili mediante staffe bullonate di ghisa poste sul lato sottostante. La geometria della griglia riproduce 3 quadrati concentrici.

Cast-iron tree grate, KJA style, square, consisting of 4 "L" shaped elements, assembled by cast-iron brackets bolted on the underside. The geometry of the grid reproduces 3 concentric squares.

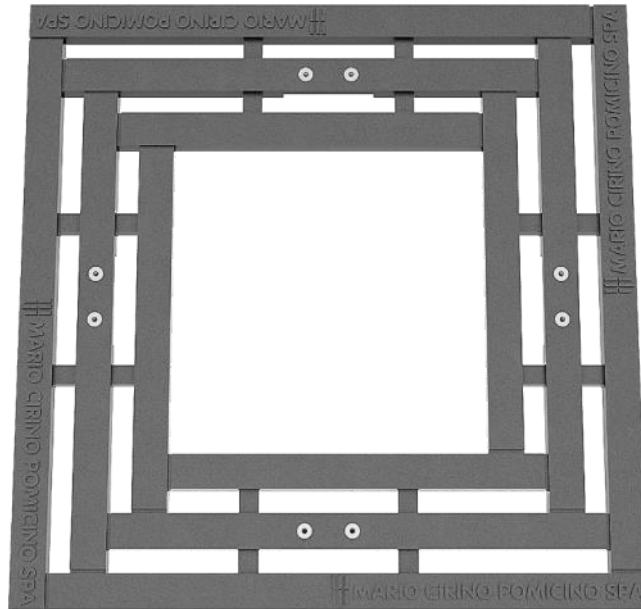
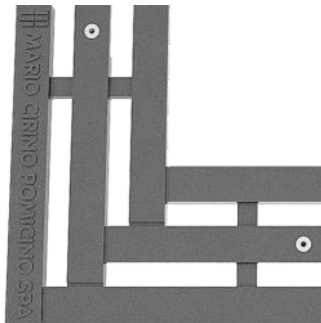

CODICE	DIM. ESTERNE	DIM. INTERNE	ALTEZZA	PESO TOTALE	NOTE	LISTINO
CODE	EXTERNAL DIMENSION	INTERNAL DIMENSION	HEIGHT	TOTAL WEIGHT	NOTES	PRICE LIST
	mm	mm	mm	Kg.		€
ALB80KJA	800X800	400X400	30	48	4 PEZZI 4 PIECES	284,00
ALB100KJA	1000X1000	600X600	40	92	4 PEZZI 4 PIECES	340,00

Arredo urbano e da giardino
Street and park furniture

103

Griglia salva piante di forma quadrata, realizzata in acciaio **VERSAILLES**

zincato UNI EN 1461 con decorazione astratta taglio laser, composta da due sezioni 2000x1000h mm con foro centrale Ø900 mm per il passaggio del fusto della pianta.

Quattro piastrine forate per il collegamento delle due sezioni.

La griglia può essere posizionata all'interno di un apposito telaio zincato a caldo secondo UNI EN 1461, da fornire separatamente.

Square-shaped plant-saving grid, made of steel galvanized UNI EN 1461 with abstract laser cut decoration, composed of two sections 2000x1000h mm with central hole Ø900 mm for the passage of the stem of the plant.

Four perforated plates for connecting the two sections.

The grid can be placed inside a special one hot-dip galvanized frame according to UNI EN 1461, to be supplied separately.

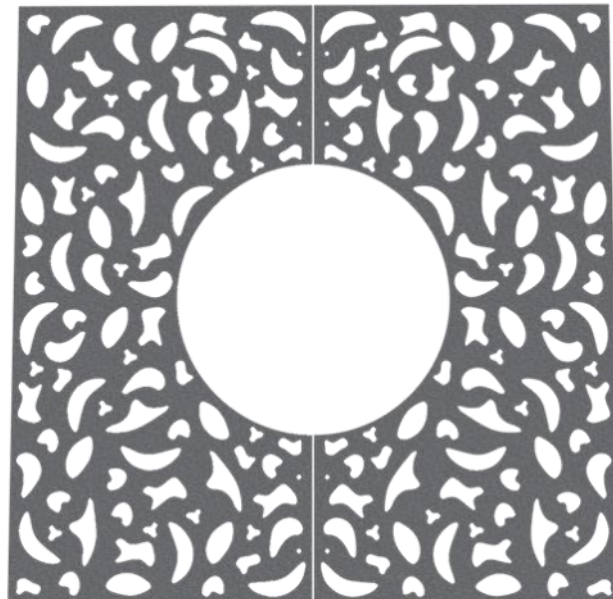

Quattro piastrine forate per il collegamento delle due sezioni.

Four perforated plates for connecting the two sections.

CODICE	DIM. ESTERNE	DIM. INTERNE	ALTEZZA	PESO TOTALE	NOTE	LISTINO
CODE	EXTERNAL DIMENSION	INTERNAL DIMENSION	HEIGHT	TOTAL WEIGHT	NOTES	PRICE LIST
	mm	mm	mm	Kg.		€
ALB200VER	2000X2000	Ø 900	25	-	2 PEZZI 2 PIECES	2.710,00

Prodotti verniciati di colore grigio ghisa
Products painted in grey cast iron



2025

Arredo urbano e da giardino
Street and park furniture

104

PROTEZIONE VERTICALE PER ALBERI

**NEW
PRODUCT**



La colonna protezione albero in acciaio zincato offre un valido e affidabile scudo per gli alberi dai danni causati da autoveicoli e/o atti vandalici. La composizione in due parti simmetriche facilita il posizionamento e l'adattamento a vari tipi di griglie per alberi, garantendo un unicum in armonia con l'ambiente.

The tree protection column in galvanized steel offers valid and reliable protection for trees from damage caused by vehicles or vandalism. Opening planned in two halves. The column is easy to position and adapts congenially to various types of tree grates, ensuring an environmentally friendly aesthetic vision.

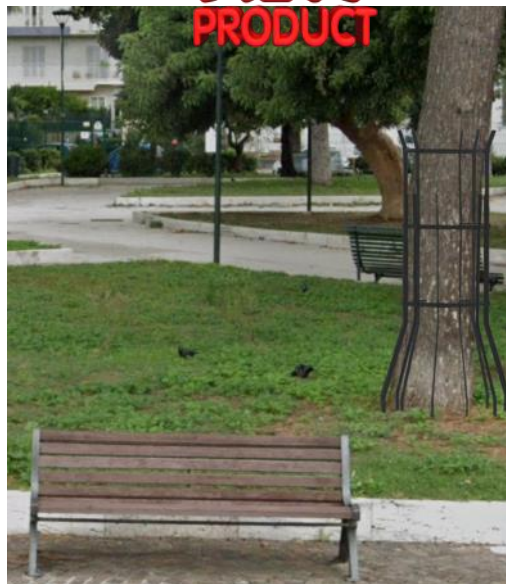

PIANI PER CAMINI

CODICE	DIM. ESTERNE	SPESSORE	PESO TOTALE	NOTE	LISTINO
CODE	EXTRNAL DIMEN- SION	THICKNESS	TOTAL WEIGHT	NOTES	PRICE LIST
	mm	mm	Kg.		€
CAM40	400X400	10	12		178,00
CAM50	500X500	10	18		267,00
CAM50/60	500X600	10	22		326,00
CAM60	600X600	10	26		385,00
CAM50/75	500X750	10	27		400,00
CAM100	1000X1000	12	96		1.420,00



↓ **DOWNLOAD**

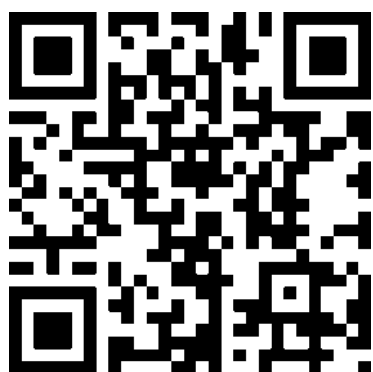

CATALOGO COMPLETO ARREDO URBANO

www.mcpomicino.it/download/

Scarica il catalogo della **linea completa** di Arredo Urbano per altri prodotti.
Download the Urban Furnishing catalogue for the whole product range.



- ▶ BITTE
BITTE
- ▶ TAVOLI
TABLES
- ▶ GAZEBI
GAZEBOO
- ▶ PALINE
VERTICAL SIGN BOARD
- ▶ BACHECHE
SHOWCASE
- ▶ PENSILINE
SHELTER

Linea completa arredo urbano

Full catalogue of urban furnishing

www.mcpomicino.it/download/

↓ **DOWNLOAD**

SIAMO NATURALI !!! RISPETTIAMO L'AMBIENTE
LET'S BE NATURAL!!! RESPECT THE ENVIRONMENT



- JUTA 
- JUTE 
- JUTE 
- JUTE 
- YUTE 



Designed by MCP SPA® in Italy



2025

Juta - Filati e Tessuti
Jute - Yarns and Clothes

106

www.mc pomicino.it
www.mcpspa.it

LA JUTA - FILATI E TESSUTI JUTE - YARNS AND CLOTHES

I prodotti in fibra di juta, naturale al 100%, sono ecologici, biodegradabili e riciclabili integralmente.

Molteplici sono le qualità intrinseche possedute dalla juta. Oltre l'elevato carico di rottura, la bassa estensibilità, l'elevata traspirazione e una moderata ritenzione di umidità, la juta possiede proprietà anti-statiche e una bassa conducibilità termica che le conferisce buona capacità isolante.

La juta è una fibra estremamente versatile e ampiamente utilizzata in molteplici settori quali:

- imballaggi;
- tessile;
- edilizia;
- agricoltura;
- industria automobilistica;
- Industria calzaturiera;
- arredamento e decorazione.

Tra gli svariati utilizzi, perlopiù tutti quelli dove è previsto l'impiego di un materiale ecologico e biodegradabile, si segnalano: l'imballaggio di prodotti agricoli; la difesa dei pendii dall'erosione; la protezione nella fase di indurimento del calcestruzzo armato.

La crescente necessità di utilizzare di prodotti eco-sostenibili ha determinato un forte incremento dell'uso della juta quale materiale base nella produzione di imballaggi in alternativa alle materie plastiche.

La juta, infine, è utilizzata per la produzione di nastri, cordoncini, rivestimento, tappezzeria, produzione di soles per scarpe, tele ad uso artistico e per decorazione.



NATURALE



BIODEGRADABLE

The natural jute products are 100% ecological, biodegradable and fully recyclable.

Jute has many qualities. In addition to the high tensile strength, low extensibility, high breathability and a moderate moisture retention, the jute possesses anti-static properties and low thermal conductivity which gives it a good insulating capacity.

The jute fiber is extremely versatile and widely used in many sectors such as:

- packaging;
- textile;
- building;
- agriculture;
- automotive industry;
- footwear;
- furniture and decoration.

Among the many uses, mostly all those that require ecological and biodegradable materials, we can also add the packaging of agricultural products, the use in the erosion defense of the slopes, protection in the hardening phase of armed concrete.

The growing need to use environmentally friendly products in recent years brought also a strong increase in using of jute as a base material in the production of packaging instead of plastic.

The Jute, finally, is used for the production of strips, cords, coatings, upholstery, production of soles for shoes, canvases artistic use and for decoration.



RICICLABILE



I prodotti tessili sono soggetti a variazione e/o tolleranze naturali di peso.



The textile products are subject to change and / or to natural tolerance weight.

TELA JUTA



JUTA122



JUTA213



JUTA305

Tessuti grezzi in Juta naturale al 100% in diverse trame ed altezze confezionati in rotoli o balle.

Cloth in 100% natural jute. Available in different textures and heights. Packaged in rolls or bales.

CODICE CODE	ALTEZZA HEIGHT	GRAMMATURA GRAMS PER SQUARE METER	CONFEZIONAMENTO PACKAGING	LISTINO PRICE LIST €
JTL100/122	100	122	ROTOLE/BALLE ROLLS/BALES	
JTL100/213	100	213	ROTOLE/BALLE ROLLS/BALES	
JTL120/213	120	213	ROTOLE/BALLE ROLLS/BALES	
JTL100/305	100	305	ROTOLE/BALLE ROLLS/BALES	
JTL140/305	140	305	ROTOLE/BALLE ROLLS/BALES	
JTL200/305	200	305	ROTOLE/BALLE ROLLS/BALES	

TELA JUTA SCOZIA

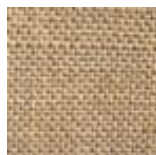

SCOZIA 275



SCOZIA 339

Tessuti in Juta naturale al 100% trattata in diverse trame e altezze confezionati in rotoli.

Cloth in 100% natural jute. Available in different colours, textures and heights. Packaged in rolls or bales.

CODICE CODE	ALTEZZA HEIGHT	GRAMMATURA GRAMS PER SQUARE METER	COLORE COLOR	CONFEZIONAMENTO PACKAGING	LISTINO PRICE LIST €
JTS140/275	140	275	NATURALE	ROTOLE ROLLS	
JTS150/339	150	339	NATURALE	ROTOLE ROLLS	
JTS150/339MLW 	150	339	MILKY-WHITE	ROTOLE ROLLS	
JTS216/339	216	339	NATURALE	ROTOLE ROLLS	



MILKY

TELA JUTA PER ARGINE



TELA

Maglia in Juta naturale 100%, idonea al contenimento e alla salvaguardia del terreno per fini anti-erosivi e di supporto alla ri-vegetazione.

100% Jute mesh soil saver for anti-erosion prevention and natural revegetation encouragement.

CODICE CODE	ALTEZZA HEIGHT	GRAMMATURA GRAMS PER SQUARE METER	CONFEZIONAMENTO PACKAGING	LISTINO PRICE LIST €
JTA122/500	122	500	BALLE BALES	



2025

Juta - Filati e Tessuti
Jute - Yarns and Clothes

107

www.mcpomicino.com
www.mcpspa.com



CONDIZIONI GENERALI DI FORNITURA

1. Il presente catalogo illustra gli articoli progettati, prodotti e commercializzati dalla MCP SPA®. Le informazioni in esso contenute, relative alle caratteristiche e alle dimensioni degli articoli, non sono vincolanti.
2. La MCP SPA® si riserva la facoltà di apportare modifiche tecniche, dimensionali ed estetiche ai prodotti e di variare i prezzi senza preavviso alcuno.
3. I pesi e le dimensioni degli articoli descritti nel presente catalogo sono puramente indicative e/o nominali e soggetti alle normali tolleranze di fusione.
4. I coperchi e le griglie dei prodotti non sono intercambiabili.
5. Il mancato rispetto delle istruzioni di posa, specificate nel documento UNI/TR 11256, esonera la MCP SPA® da qualsiasi responsabilità, anche verso terzi.
6. I prodotti illustrati nel presente catalogo sono tutti garantiti dalla MCP SPA®, eventuali reclami devono essere comunicati per iscritto e nei termini di legge. Non verranno presi in considerazione i reclami trascorsi l'anno dalla consegna dei beni. Ad evitare inconvenienti i clienti sono invitati ad una verifica visiva dei prodotti all'atto della consegna e prima della posa in opera di verificare la coplanarità del coperchio col telaio. La MCP SPA® raccomanda di non intercambiare i coperchi con i telai. In caso di difetti riscontrati, la MCP SPA® sostituirà solo la merce difettosa; è esclusa per l'acquirente la risoluzione del contratto, la richiesta di risarcimento danni e la sospensione dei pagamenti. È esclusa, altresì, la garanzia in caso di manomissione dei prodotti.
7. Eventuali quantità mancanti alla consegna dovranno essere annotate sul documento di accompagnamento ed in contraddittorio con il vettore incaricato.
8. L'eventuale richiesta di reso di materiale dovrà pervenire entro 3 gg. dalla data di ritiro. In caso di accettazione da parte della MCP SPA®, il reso dovrà pervenire, a cura e spesa del richiedente, presso la sede di Casandrino entro e non oltre il 20° giorno dalla data di accettazione.
9. Il logo e il marchio "MCP SPA®" sono registrati.
10. I marchi ed i loghi riprodotti nel presente catalogo sono di proprietà delle aziende di appartenenza. Eventuali ordini di merci con la loro riproduzione devono essere corredati, al momento dell'ordine, dell'autorizzazione rilasciata dal titolare del marchio e/o logo.
11. E' vietata la riproduzione, anche parziale, di testi ed immagini contenuti nel presente catalogo.
12. Per ogni controversia è competente il foro di Napoli sede centrale.
13. Ai sensi dell'art.1523 del codice civile, la MCP SPA® si riserva la proprietà dei prodotti forniti fino all'integrale pagamento della commessa da parte del cliente.
14. Oltre che nei casi di forza maggiore e in quelli previsti dalla legge, la MCP SPA® avrà libera facoltà di recedere dal contratto di vendita già concluso, ovvero di sospendere le trattative pendenti, in tutto o in parte senza che ciò comporti alcun diritto risarcitorio per l'acquirente, qualora si verificassero, in qualsiasi luogo, fatti o circostanze che alterino sostanzialmente lo stato dei mercati e il valore della moneta (compreso la svalutazione e la solvibilità dell'acquirente). Decorrenza: trentuno dicembre duemilaventicinque.
15. Le immagini presenti nel catalogo sono state ottimizzate graficamente.
16. Le tipologie dei prodotti richiamate nel presente catalogo sono subordinate alla effettiva disponibilità, verificabile contattando gli operatori della MCP.
17. Ai sensi del D.lgs 196/2003 e del GDPR 679/2016 (trattamento dei dati personali e privacy) gli acquirenti resi consapevoli delle modalità e finalità del trattamento dei dati personali, devono esprimere il proprio consenso scritto prima dell'inizio dei rapporti commerciali.
18. Fare attenzione durante la movimentazione del chiusino e/o caditoia a non urtare il telaio con forche dei carrelli e/o altro automezzo di carico

GENERAL TERMS AND CONDITIONS

1. The present catalogue shows the products designed, produced and marketed by MCP SPA®. The information relating to the characteristics and dimensions of the products contained herein are not binding.
2. The MCP SPA® reserves the right to make technical, dimensional and design changes to products and to change prices without notice.
3. The weight and size of the products listed in this catalogue are approximate and subject to normal manufacturing tolerances.
4. The covers and grates of products are not interchangeable.
5. The inobservance of the installation instructions, listed into UNI/TR 11256 document, relieves MCP SPA® from any kind of responsibility, third parties included.
6. Products shown in this catalogue are all guaranteed by MCP SPA®; Any claims must be forwarded in writing and within the time limits established by law. The complaints received after one year from delivery of the goods will not be taken into consideration. Customers are invited to a visual check of the products upon delivery and before installation to check the coplanarity of the cover with the frame to avoid inconveniences. The MCP SPA® recommended to do not interchange the covers with the frames. In case defects are found, MCP SPA® replaces only the defective goods, It is excluded to the buyer the cancellation of the contract, the claim for damages and the suspension of payments. It is also excluded, the guarantee in case of product tampering.
7. Any missing quantities to delivery will have to be recorded with the presence of the carrier on the accompanying document.
8. Any eventual request of goods return must be received within 3 days from the withdrawal date. In case the request is accepted by MCP SPA®, the returned goods must be received at the headquarters of Casandrino no later than 20 days from the acceptance date, on responsibility and expense of the applicant.
9. "MCP SPA®" brand and logo are registered trademarks.
10. The trademarks and logos displayed in this catalogue are property of their respective owners. Any orders for goods with their reproduction must be accompanied with the authorization granted by the owner of the mark and / or logo at the time of the order.
11. Reproduction, even partial, of texts and images displayed on the present catalogue is forbidden.
12. Any dispute will be referred to the court of Napoli.
13. Pursuant to Article 1523 Italian Civil Code, MCP SPA® reserves the ownership of the goods supplied until the full order payment by the customer.
14. Should they occur in any place, any facts or circumstances that substantially alter the state of the markets and the value of money (including depreciation) and the solvency of the buyer, MCP SPA® has the right to cancel the already signed sales contract or to suspend negotiations pending, in whole or in part without implying any compensation to the buyer, in addition to cases of force majeure and those required by law. Catalogue effectiveness from thirty-first December two thousand and twenty-five.
15. The images displayed in the present catalogue have been graphically optimized.
16. The typologies shown in the present catalog are subject to availability, verifiable by contacting our sales agents.
17. Pursuant to Legislative decree 196/2003 ant to the GDPR 679/2016 (processing of personal data and privacy) the purchasers made aware of the purposes and modalities of personal data processing, must give their consent in writing before the commercial transactions.
18. Be careful: when handling the products not to hit the frames of the manhole covers gully tops with the forks of the forklift trucks or other loading vehicles.

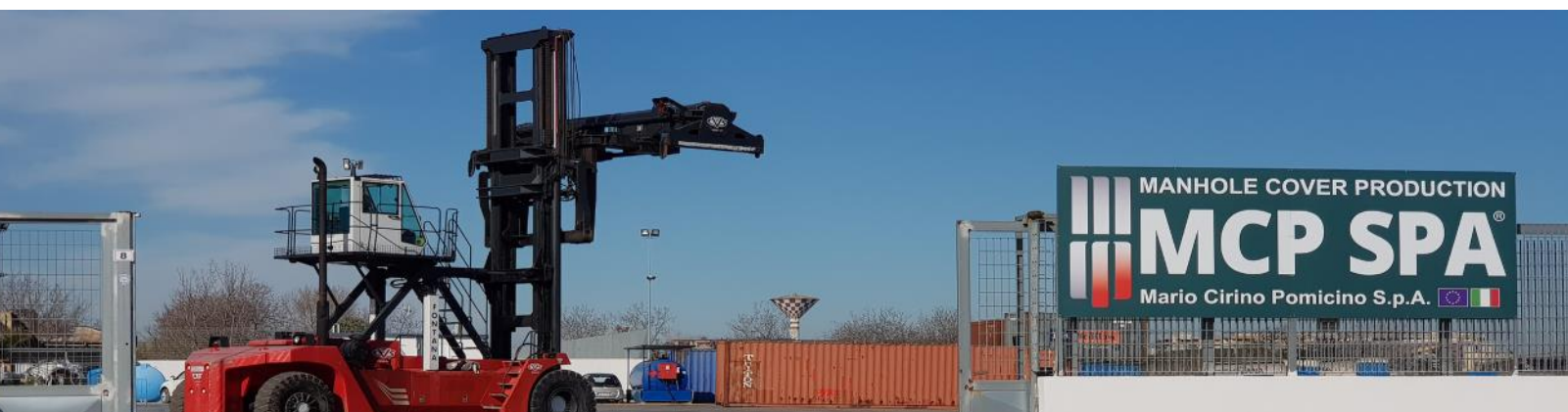

Unica sede legale e operativa:

Via Campo dei Fiori, 11
80025 - Casandrino (Na) Italia
P.Iva 01256021211
C.F. 01304940636
SDI : A4707H7

E-Mail

info@mcpomicino.com

Amministrazione

amministrazione@mcpomicino.it

Pec

amministrazione@pec.mcpomicino.it

rivenditori@pec.mcpomicino.it

imprese@pec.mcpomicino.it

PBX 100 linee

+39 081 573 47 40

+39 081 710 60 08 +39 081 731 53 13

+39 081 573 98 05 +39 081 731 50 01

+39 081 573 14 18 +39 081 573 17 64

+39 366 351 60 37 +39 335 745 60 17

+39 347 611 57 48

Vendita

rivenditori@mcpomicino.it

imprese@mcpomicino.it

Tessile

tessile@mcpomicino.it

Tecnico

tecnico@mcpomicino.it

Logistica

logistica@mcpomicino.it

Import / Export

importmcp@mcpomicino.com

foreign@mcpomicino.it

sales@mcpomicino.it



Download Catalogo

Follow us on



YouTube



www.mcpomicino.it

Designed by MCP SPA® in Italy